

Anwendung

Industrieventilator zum Fördern sauberer oder leicht verschmutzter, chemisch neutraler Luft. Typische Anwendungen:

- Luftpressen in technologischen Prozessen,
- Kühlsysteme,
- Lufttrocknungssysteme.

Konstruktion

- Mitteldruck, Direktantrieb, Radialventilator,
- Aluminiumblechrotor mit rückwärts geneigten Schaufeln, ausgewuchtet nach ISO 1940-1,
- rechteckiges geschweißtes Stahlgehäuse,
- lackiert RAL 5010 (blau), Korrosivitätskategorie C3,
- mittlere Höchsttemperatur 80°C,
- Umgebungstemperatur des Motors von -20 °C bis +40 °C,
- Je nach Motorleistung sind die Lüfter standardmäßig zweistellig LG90 und LG270 (siehe Spezifikationstabelle).

Motor

- asynchron, dreiphasig 230V/400V 50Hz oder 400/690V 50Hz, Effizienzklasse IE3,
- Schutzart IP55,
- Isolierstoffklasse F,
- Drehstrommotoren sind für Frequenzumrichter geeignet.

Sonderausführungen

- optionale Konfiguration LG/RD,
- andere Farbe als Standard und höhere Korrosivitätskategorie,
- Gehäuse und Halterung aus verzinktem Stahl Stahlblech, Edelstahl 1.4301, säurefester Stahl 1.4404,
- Motor mit Spannung und Frequenz der Leistung, Schutzart abweichend vom Standard, ausgestattet mit Sensoren oder zusätzlicher Kühlung,
- Abdichtung zwischen Gehäuse und Motor,
- HT-Version - maximale Temperatur des transportierten Mediums höher als Standard,
- Umgebungstemperaturbereich unter -20°C und über +40°C,
- Riementrieb, Kupplung,
- ATEX-Version.

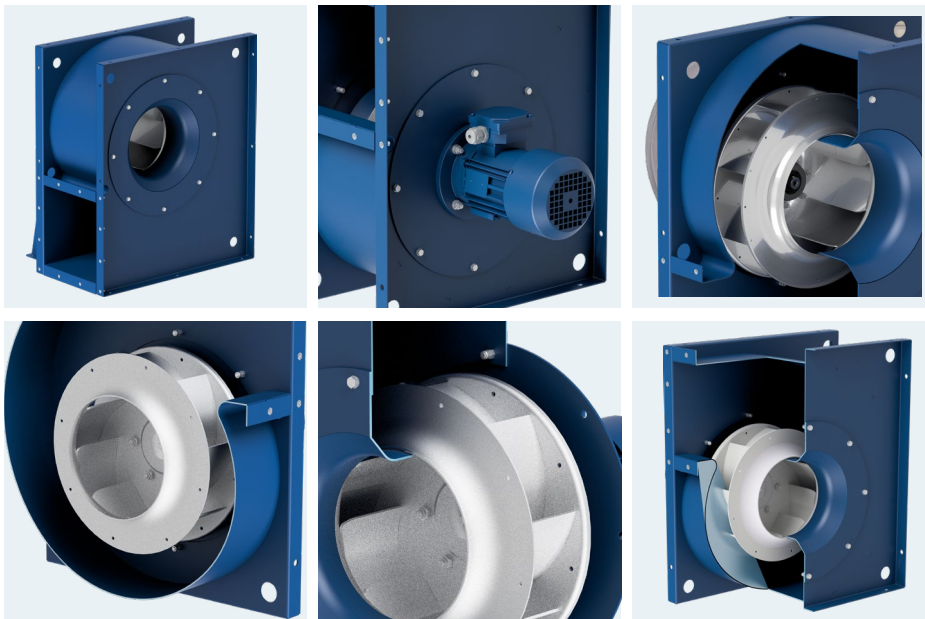

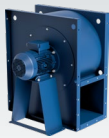

NENNDATEN

Type	Volumenstrom max	Druck max	Motor Drehzahl	Nennspannung	Nennstrom**	Motorleistung	Schall-druckpegel Fall*	Temperaturbetrieb min / max	Gewicht	Figur	Artikelnummer
DREIPHASIGE, 3000RPM											
GMB-2-25A-018T	1 250 m ³ /h	760 Pa	2 750 rpm	3~400 V	0,5 A	0,18 kW	53 dB(A)	-20 / 80 °C	19,0 kg	LG90	433552500
GMB-2-25B-025T	1 615 m ³ /h	870 Pa	2 780 rpm	3~400 V	0,65 A	0,25 kW	56 dB(A)	-20 / 80 °C	20,0 kg	LG90	433552501
GMB-2-25C-037T	1 850 m ³ /h	925 Pa	2 870 rpm	3~400 V	0,95 A	0,37 kW	58 dB(A)	-20 / 80 °C	21,0 kg	LG90	433552502
GMB-2-28A-037T	1 760 m ³ /h	950 Pa	2 870 rpm	3~400 V	0,95 A	0,37 kW	57 dB(A)	-20 / 80 °C	26,0 kg	LG90	433552510
GMB-2-28B-055T	2 300 m ³ /h	1 090 Pa	2 870 rpm	3~400 V	1,25 A	0,55 kW	59 dB(A)	-20 / 80 °C	27,0 kg	LG90	433552511
GMB-2-28C-055T	2 600 m ³ /h	1 155 Pa	2 850 rpm	3~400 V	1,25 A	0,55 kW	62 dB(A)	-20 / 80 °C	28,0 kg	LG90	433552512
GMB-2-31A-055T	2 500 m ³ /h	1 200 Pa	2 870 rpm	3~400 V	1,25 A	0,55 kW	60 dB(A)	-20 / 80 °C	32,0 kg	LG90	433552520
GMB-2-31B-075T	3 250 m ³ /h	1 380 Pa	2 850 rpm	3~400 V	1,65 A	0,75 kW	62 dB(A)	-20 / 80 °C	35,0 kg	LG90	433552521
GMB-2-31C-110T	3 700 m ³ /h	1 460 Pa	2 840 rpm	3~400 V	2,2 A	1,1 kW	65 dB(A)	-20 / 80 °C	36,0 kg	LG90	433552522
GMB-2-35A-110T	3 560 m ³ /h	1 530 Pa	2 840 rpm	3~400 V	2,2 A	1,1 kW	64 dB(A)	-20 / 80 °C	48,0 kg	LG90	433552530
GMB-2-35B-150T	4 600 m ³ /h	1 750 Pa	2 925 rpm	3~400 V	3 A	1,5 kW	67 dB(A)	-20 / 80 °C	52,0 kg	LG90	433552531
GMB-2-35C-220T	5 300 m ³ /h	1 850 Pa	2 900 rpm	3~400 V	4,3 A	2,2 kW	69 dB(A)	-20 / 80 °C	54,0 kg	LG90	433552532
GMB-2-40A-150T	5 090 m ³ /h	1 945 Pa	2 925 rpm	3~400 V	3 A	1,5 kW	38 dB(A)	-20 / 80 °C	56,0 kg	LG90	433552540
GMB-2-40B-220T	6 600 m ³ /h	2 220 Pa	2 900 rpm	3~400 V	4,3 A	2,2 kW	69 dB(A)	-20 / 80 °C	58,0 kg	LG90	433552541
GMB-2-40C-300T	7 500 m ³ /h	2 360 Pa	2 915 rpm	3~400 V	5,8 A	3,0 kW	73 dB(A)	-20 / 80 °C	64,0 kg	LG90	433552542
GMB-2-45A-300T	7 200 m ³ /h	2 455 Pa	2 915 rpm	3~400 V	5,8 A	3,0 kW	71 dB(A)	-20 / 80 °C	95,0 kg	LG90	433552550
GMB-2-45B-400T	9 400 m ³ /h	2 810 Pa	2 925 rpm	3~400 V	7,4 A	4,0 kW	74 dB(A)	-20 / 80 °C	104,0 kg	LG270	433552551
GMB-2-45C-550T	10 750 m ³ /h	3 000 Pa	2 940 rpm	3~400 V	10 A	5,5 kW	76 dB(A)	-20 / 80 °C	104,0 kg	LG270	433552552
GMB-2-50A-550T	9 950 m ³ /h	3 030 Pa	2 940 rpm	3~400 V	10 A	5,5 kW	74 dB(A)	-20 / 80 °C	114,0 kg	LG270	433552560
GMB-2-50B-750T	13 055 m ³ /h	3 470 Pa	2 940 rpm	3~400 V	13,3 A	7,5 kW	76 dB(A)	-20 / 80 °C	132,0 kg	LG270	433552561
GMB-2-50C-1100T	14 720 m ³ /h	3 700 Pa	2 925 rpm	3~400 V	19,6 A	11,0 kW	79 dB(A)	-20 / 80 °C	163,0 kg	LG270	433552562
GMB-2-56A-1100T	11 880 m ³ /h	4 375 Pa	2 925 rpm	3~400 V	19,6 A	11,0 kW	78 dB(A)	-20 / 80 °C	223,0 kg	LG270	433552570
GMB-2-56B-1500T	16 600 m ³ /h	4 590 Pa	2 945 rpm	3~400 V	26,2 A	15,0 kW	80 dB(A)	-20 / 80 °C	259,0 kg	LG270	433552571
GMB-2-56C-1850T	21 050 m ³ /h	4 630 Pa	2 940 rpm	3~400 V	32,1 A	18,5 kW	84 dB(A)	-20 / 80 °C	266,0 kg	LG270	433552572
GMB-2-63A-1850T	16 885 m ³ /h	5 535 Pa	2 940 rpm	3~400 V	32,1 A	18,5 kW	81 dB(A)	-20 / 80 °C	279,0 kg	LG270	433552580
GMB-2-63B-2200T	23 550 m ³ /h	5 800 Pa	2 955 rpm	3~400 V	38,1 A	22,0 kW	82 dB(A)	-20 / 80 °C	325,0 kg	LG270	433552581
GMB-2-63C-3000T	29 580 m ³ /h	5 900 Pa	2 965 rpm	3~400 V	51 A	30,0 kW	85 dB(A)	-20 / 80 °C	410,0 kg	LG270	433552582

* Messung in 1,5 m Entfernung vom Auslass, für Q = 2/3 * Qmax
 ** Der Nennstrom ist abhängig von eingesetztem Motorfabrikat.

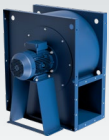

NENNDATEN

Type	Volumenstrom max	Druck max	Motor Drehzahl	Nennspannung	Nennstrom**	Motorleistung	Schall-druckpegel Fall*	Temperaturbetrieb min / max	Gewicht	Figur	Artikelnummer
DREIPHASIGE, 1500RPM											
GMB-4-35A-012T	1 780 m ³ /h	385 Pa	1 400 rpm	3~400 V	0,42 A	0,12 kW	50 dB(A)	-20 / 80 °C	40,0 kg	LG90	433552533
GMB-4-35B-018T	2 300 m ³ /h	435 Pa	1 400 rpm	3~400 V	0,55 A	0,18 kW	52 dB(A)	-20 / 80 °C	41,0 kg	LG90	433552534
GMB-4-35C-025T	2 650 m ³ /h	465 Pa	1 410 rpm	3~400 V	0,8 A	0,25 kW	54 dB(A)	-20 / 80 °C	42,0 kg	LG90	433552535
GMB-4-40A-018T	2 545 m ³ /h	485 Pa	1 400 rpm	3~400 V	0,55 A	0,18 kW	53 dB(A)	-20 / 80 °C	44,0 kg	LG90	433552543
GMB-4-40B-025T	3 300 m ³ /h	555 Pa	1 410 rpm	3~400 V	0,8 A	0,25 kW	55 dB(A)	-20 / 80 °C	45,0 kg	LG90	433552544
GMB-4-40C-037T	3 760 m ³ /h	590 Pa	1 410 rpm	3~400 V	1,1 A	0,37 kW	58 dB(A)	-20 / 80 °C	46,0 kg	LG90	433552545
GMB-4-45A-037T	3 600 m ³ /h	615 Pa	1 410 rpm	3~400 V	1,1 A	0,37 kW	56 dB(A)	-20 / 80 °C	76,0 kg	LG90	433552553
GMB-4-45B-055T	4 700 m ³ /h	700 Pa	1 420 rpm	3~400 V	1,6 A	0,55 kW	58 dB(A)	-20 / 80 °C	77,0 kg	LG90	433552554
GMB-4-45C-075T	5 375 m ³ /h	750 Pa	1 430 rpm	3~400 V	2,1 A	0,75 kW	61 dB(A)	-20 / 80 °C	77,0 kg	LG90	433552555
GMB-4-50A-075T	4 975 m ³ /h	760 Pa	1 430 rpm	3~400 V	2,1 A	0,75 kW	59 dB(A)	-20 / 80 °C	88,0 kg	LG90	433552563
GMB-4-50B-110T	6 530 m ³ /h	870 Pa	1 450 rpm	3~400 V	2,5 A	1,1 kW	61 dB(A)	-20 / 80 °C	96,0 kg	LG90	433552564
GMB-4-50C-150T	7 360 m ³ /h	925 Pa	1 450 rpm	3~400 V	3,3 A	1,5 kW	64 dB(A)	-20 / 80 °C	99,0 kg	LG90	433552565
GMB-4-56A-110T	5 940 m ³ /h	1090 Pa	1 450 rpm	3~400 V	2,5 A	1,1 kW	63 dB(A)	-20 / 80 °C	145,0 kg	LG90	433552573
GMB-4-56B-150T	8 295 m ³ /h	1 150 Pa	1 465 rpm	3~400 V	3,3 A	1,5 kW	64 dB(A)	-20 / 80 °C	148,0 kg	LG90	433552574
GMB-4-56C-220T	10 525 m ³ /h	1 160 Pa	1 465 rpm	3~400 V	4,6 A	2,2 kW	67 dB(A)	-20 / 80 °C	160,0 kg	LG270	433552575
GMB-4-63A-220T	8 440 m ³ /h	1 385 Pa	1 465 rpm	3~400 V	4,6 A	2,2 kW	66 dB(A)	-20 / 80 °C	168,0 kg	LG270	433552583
GMB-4-63B-300T	11 775 m ³ /h	1 450 Pa	1 465 rpm	3~400 V	6,3 A	3,0 kW	67 dB(A)	-20 / 80 °C	172,0 kg	LG270	433552584
GMB-4-63C-400T	14 790 m ³ /h	1 475 Pa	1 460 rpm	3~400 V	8,1 A	4,0 kW	70 dB(A)	-20 / 80 °C	183,0 kg	LG270	433552585
GMB-4-71A-400T	12 080 m ³ /h	1 760 Pa	1 460 rpm	3~400 V	8,1 A	4,0 kW	70 dB(A)	-20 / 80 °C	238,0 kg	LG270	433552593
GMB-4-71B-550T	16 800 m ³ /h	1 845 Pa	1 460 rpm	3~400 V	11,1 A	5,5 kW	71 dB(A)	-20 / 80 °C	267,0 kg	LG270	433552594
GMB-4-71C-750T	21 475 m ³ /h	1 870 Pa	1 465 rpm	3~400 V	14,4 A	7,5 kW	73 dB(A)	-20 / 80 °C	268,0 kg	LG270	433552595
GMB-4-80A-750T	17 280 m ³ /h	2 230 Pa	1 465 rpm	3~400 V	14,4 A	7,5 kW	74 dB(A)	-20 / 80 °C	327,0 kg	LG270	433552603
GMB-4-80B-1100T	24 050 m ³ /h	2 340 Pa	1 460 rpm	3~400 V	20,9 A	11,0 kW	75 dB(A)	-20 / 80 °C	357,0 kg	LG270	433552604
GMB-4-80C-1500T	30 250 m ³ /h	2 375 Pa	1 475 rpm	3~400 V	28,3 A	15,0 kW	77 dB(A)	-20 / 80 °C	414,0 kg	LG270	433552605
DREIPHASIGE, 1000RPM											
GMB-6-71A-110T	7 915 m ³ /h	755 Pa	940 rpm	3~400 V	2,8 A	1,1 kW	62 dB(A)	-20 / 80 °C	213,0 kg	LG90	433552596
GMB-6-71B-150T	11 000 m ³ /h	790 Pa	960 rpm	3~400 V	3,5 A	1,5 kW	63 dB(A)	-20 / 80 °C	232,0 kg	LG270	433552597
GMB-6-71C-220T	13 850 m ³ /h	800 Pa	965 rpm	3~400 V	5 A	2,2 kW	64 dB(A)	-20 / 80 °C	241,0 kg	LG270	433552598
GMB-6-80A-220T	11 320 m ³ /h	960 Pa	965 rpm	3~400 V	5 A	2,2 kW	65 dB(A)	-20 / 80 °C	294,0 kg	LG270	433552606
GMB-6-80B-300T	15 750 m ³ /h	1 005 Pa	965 rpm	3~400 V	6,2 A	3,0 kW	66 dB(A)	-20 / 80 °C	314,0 kg	LG270	433552607
GMB-6-80C-400T	19 800 m ³ /h	1 020 Pa	965 rpm	3~400 V	8,1 A	4,0 kW	67 dB(A)	-20 / 80 °C	326,0 kg	LG270	433552608

* Messung in 1,5 m Entfernung vom Auslass, für Q = 2/3 * Q_{max}
 ** Der Nennstrom ist abhängig von eingesetztem Motorfabrikat.

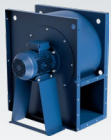

LEISTUNGSMERKMALE DER VENTILATOREN - DREIPHASIGE 3000RPM

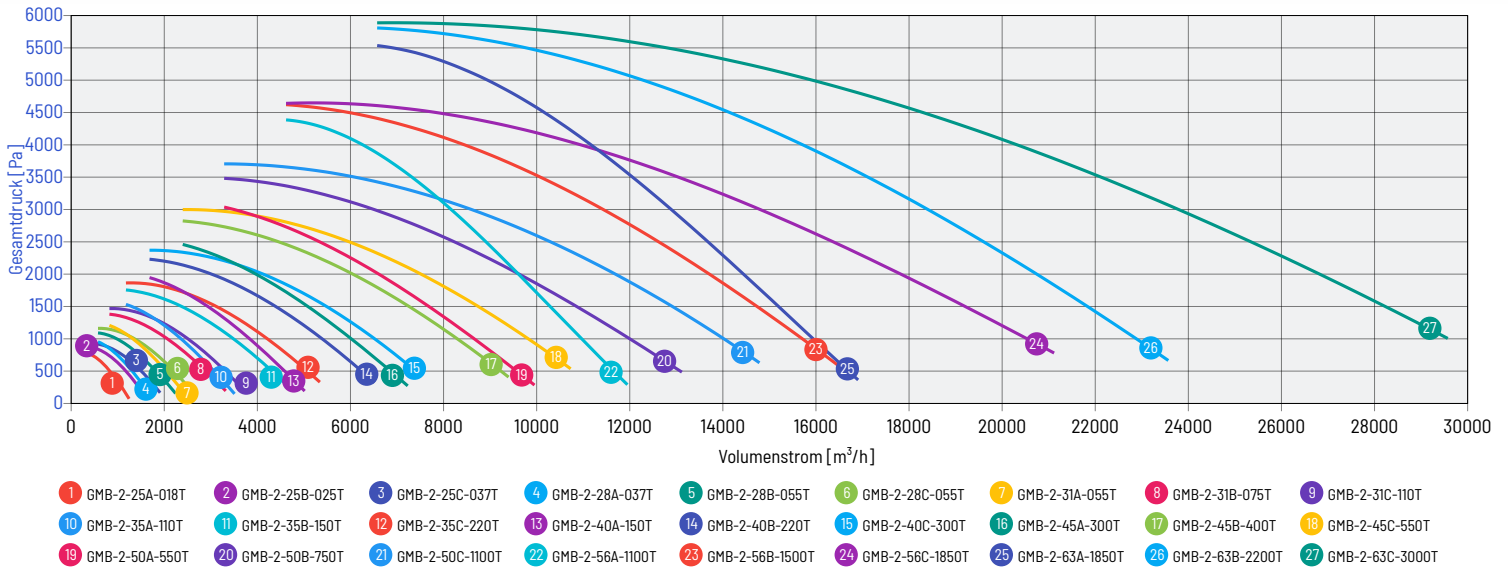

LEISTUNGSMERKMALE DER VENTILATOREN - DREIPHASIGE 1500RPM

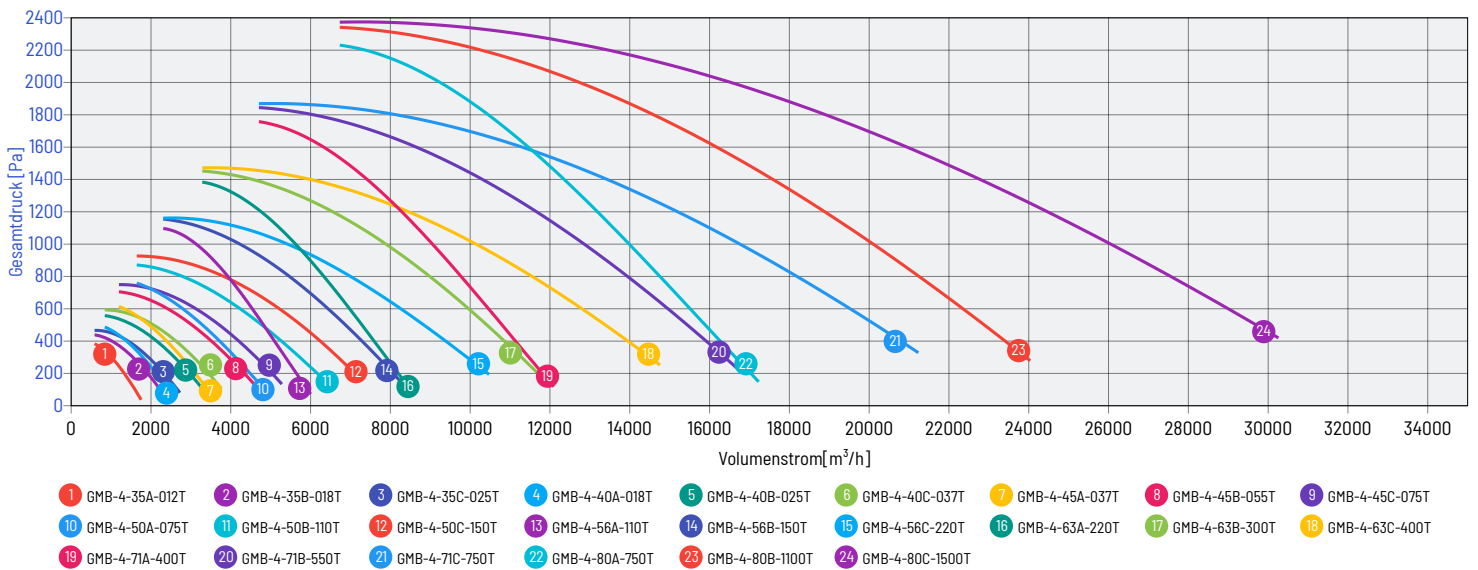

LEISTUNGSMERKMALE DER VENTILATOREN - DREIPHASIGE 1000RPM

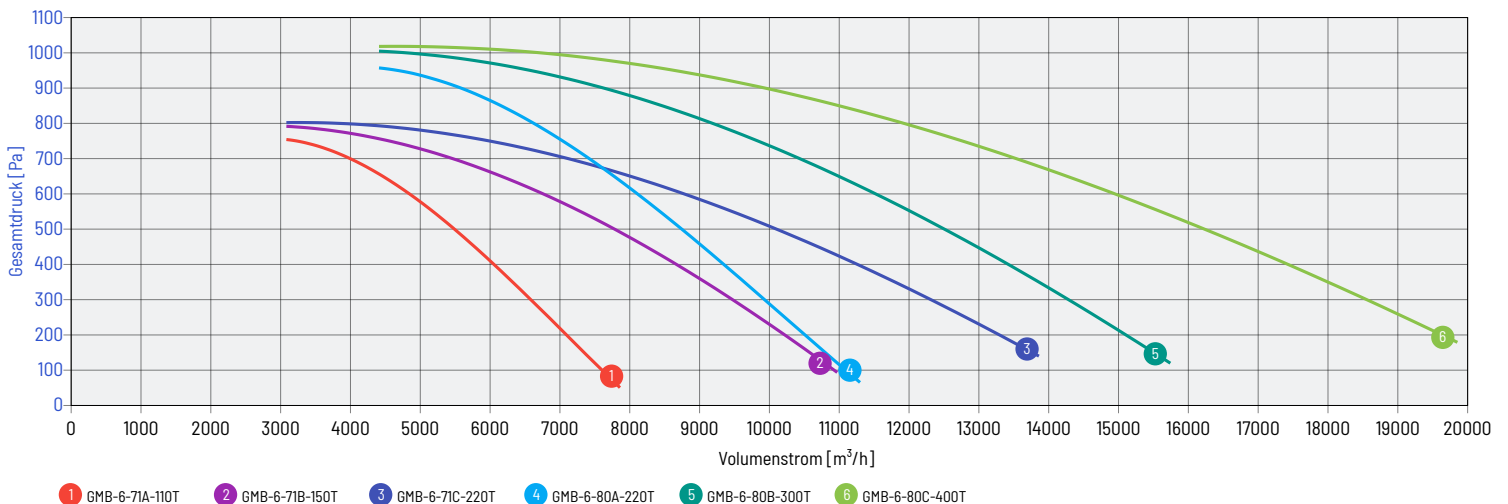

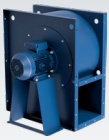

KENNLINIEN

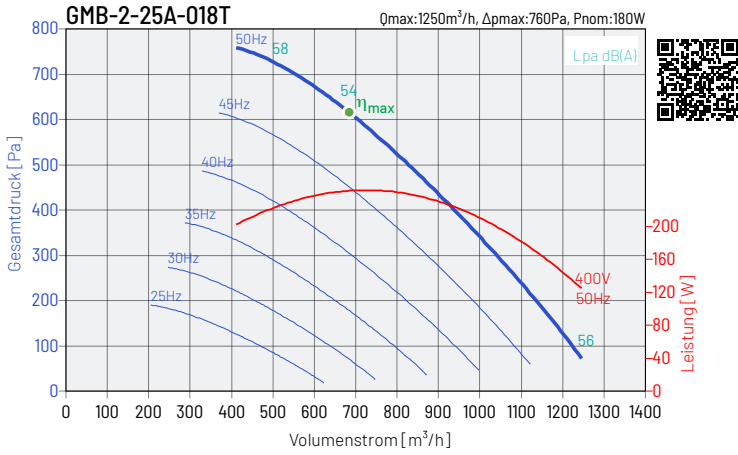

MC	EC	SR	VSD	$\eta\%$	N	kW	m³/h	Pa	rpm
C	statisch	1	nein	46,4	63,3	0,24	685	592	2 750

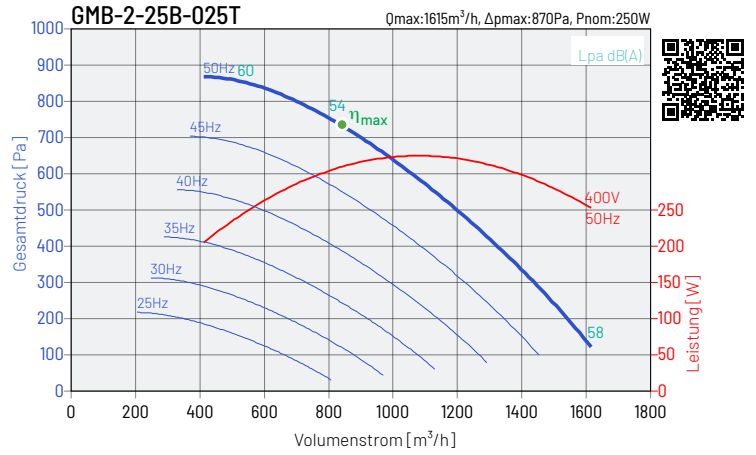

MC	EC	SR	VSD	$\eta\%$	N	kW	m³/h	Pa	rpm
C	statisch	1	nein	52,8	68,7	0,31	822	710	2 780

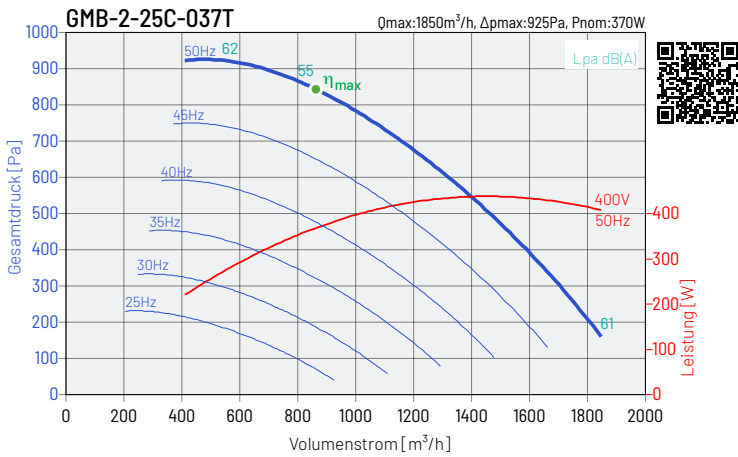

MC	EC	SR	VSD	$\eta\%$	N	kW	m³/h	Pa	rpm
C	statisch	1	nein	52,6	67,7	0,36	822	824	2 870

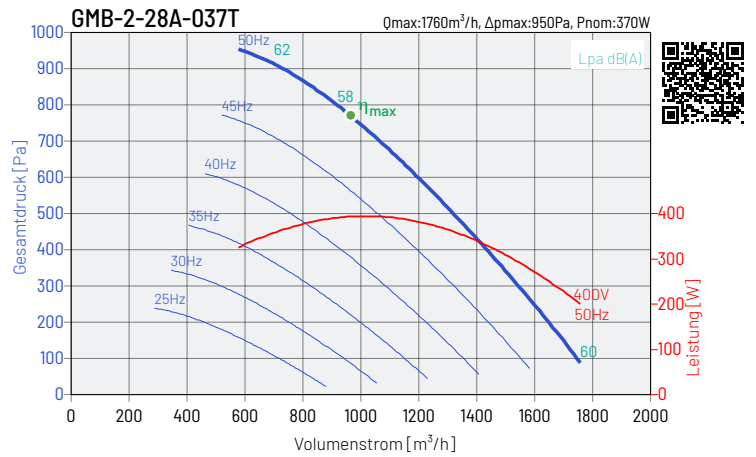

MC	EC	SR	VSD	$\eta\%$	N	kW	m³/h	Pa	rpm
C	statisch	1	nein	50,5	65,3	0,39	962	743	2 870

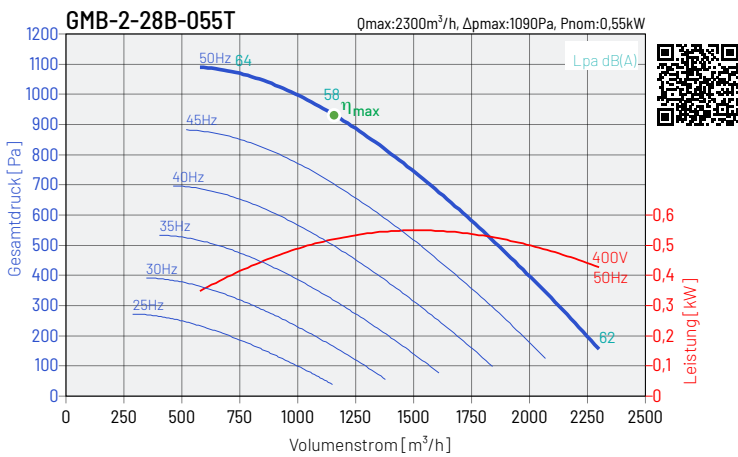

MC	EC	SR	VSD	$\eta\%$	N	kW	m³/h	Pa	rpm
C	statisch	1	nein	55,0	68,5	0,52	1154	891	2 870

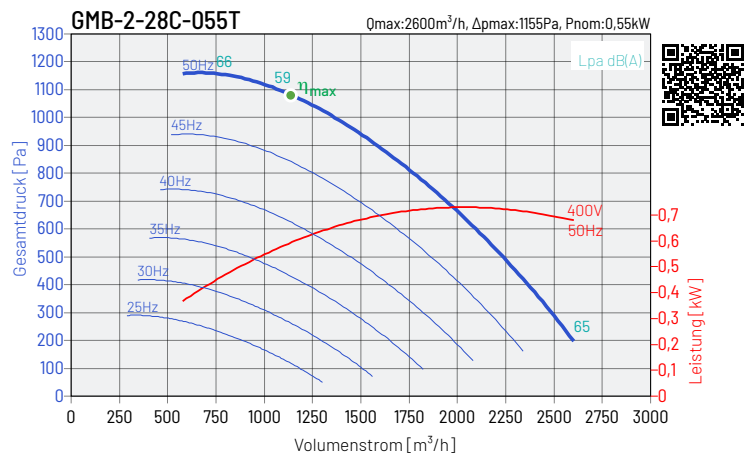

MC	EC	SR	VSD	$\eta\%$	N	kW	m³/h	Pa	rpm
C	statisch	1	nein	55,5	68,3	0,60	1154	1035	2 850

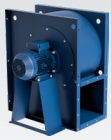

KENNLINIEN

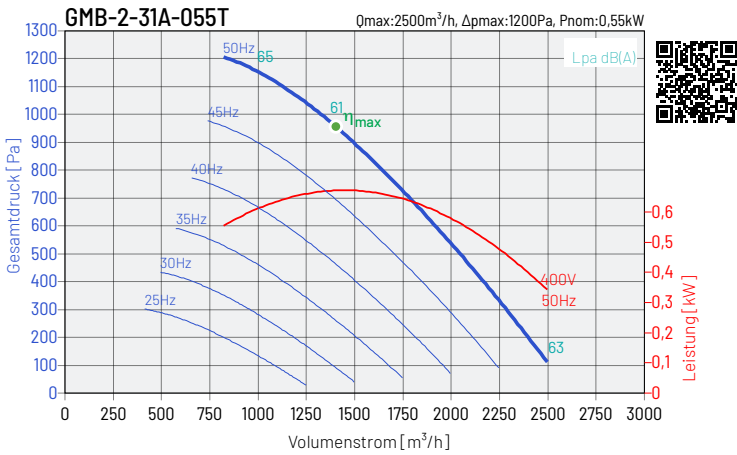

MC	EC	SR	VSD	$\eta\%$	N	kW	m^3/h	Pa	rpm
C	statisch	1	nein	53,3	65,7	0,67	1370	939	2870

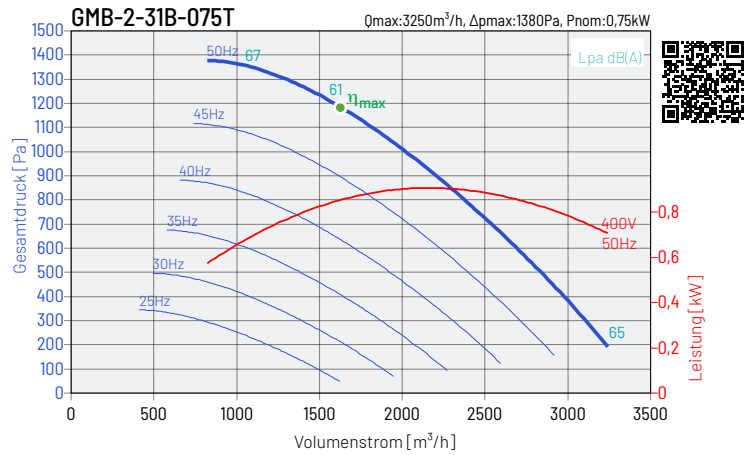

MC	EC	SR	VSD	$\eta\%$	N	kW	m^3/h	Pa	rpm
C	statisch	1	nein	60,0	71,2	0,86	1644	1125	2850

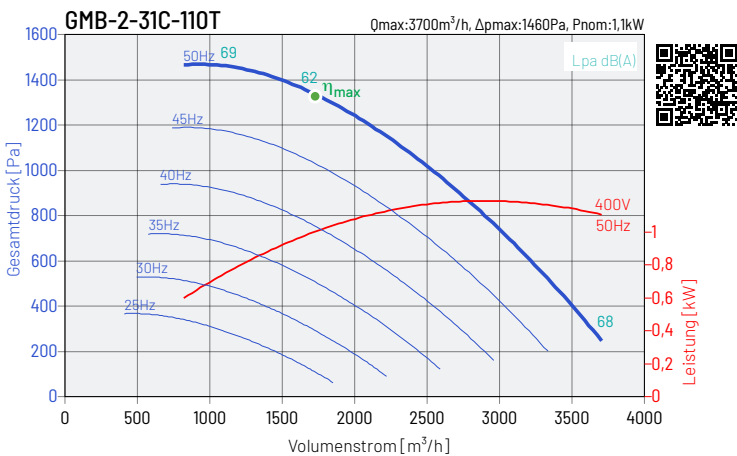

MC	EC	SR	VSD	$\eta\%$	N	kW	m^3/h	Pa	rpm
C	statisch	1	nein	61,3	71,9	0,97	1644	1307	2840

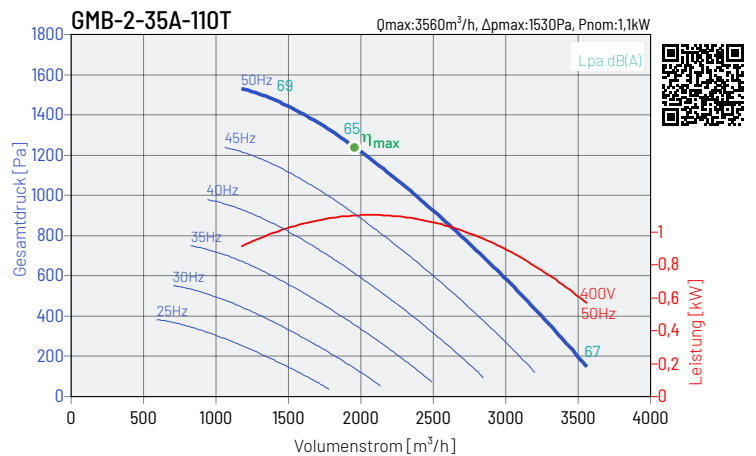

MC	EC	SR	VSD	$\eta\%$	N	kW	m^3/h	Pa	rpm
C	statisch	1	nein	58,9	69,0	1,10	1961	1191	2840

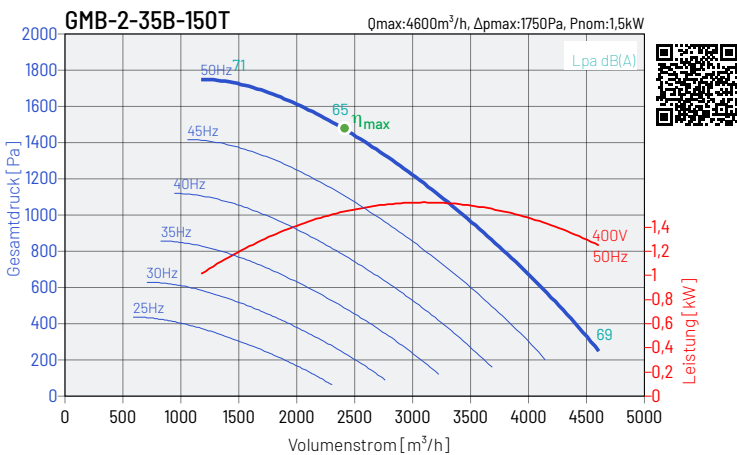

MC	EC	SR	VSD	$\eta\%$	N	kW	m^3/h	Pa	rpm
C	statisch	1	nein	61,6	70,2	1,52	2353	1428	2925

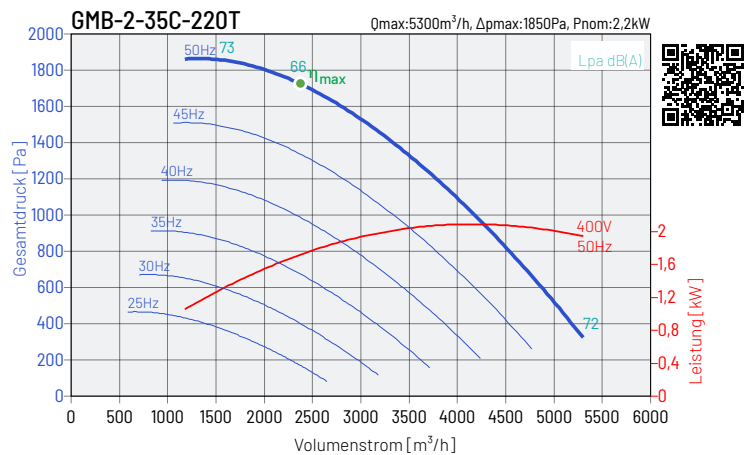

MC	EC	SR	VSD	$\eta\%$	N	kW	m^3/h	Pa	rpm
C	statisch	1	nein	63,4	71,4	1,71	2353	1659	2900

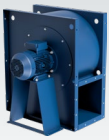

KENNLINIEN

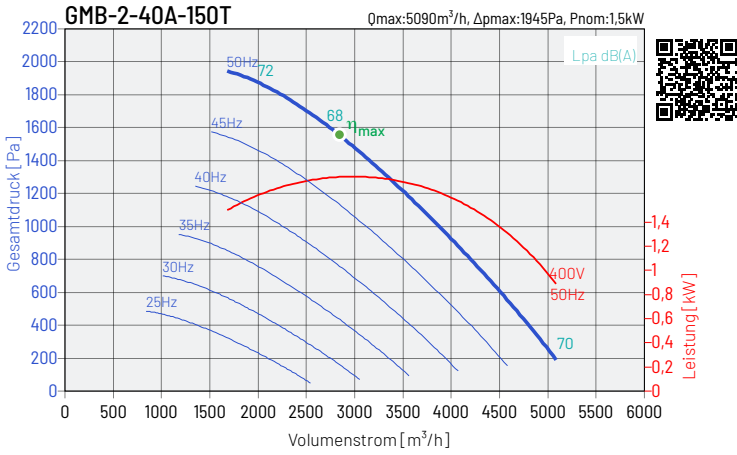

MC	EC	SR	VSD	$\eta\%$	N	kW	m ³ /h	Pa	rpm
C	statisch	1	nein	67,0	74,9	1,76	2 805	1 512	2 925

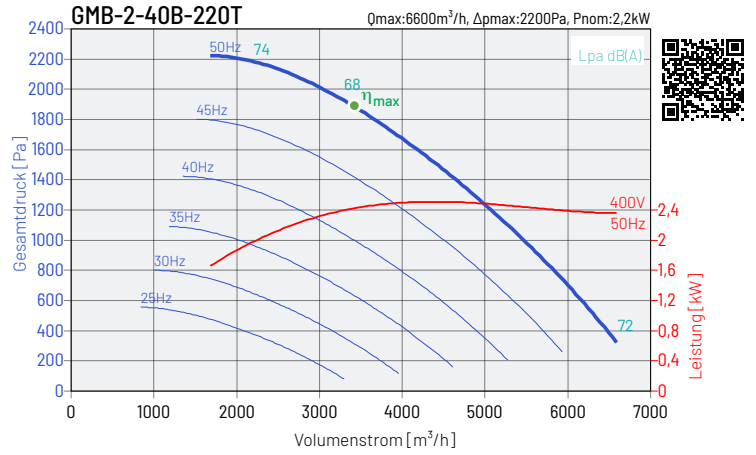

MC	EC	SR	VSD	$\eta\%$	N	kW	m ³ /h	Pa	rpm
C	statisch	1	nein	70,3	76,8	2,41	3 365	1 816	2 900

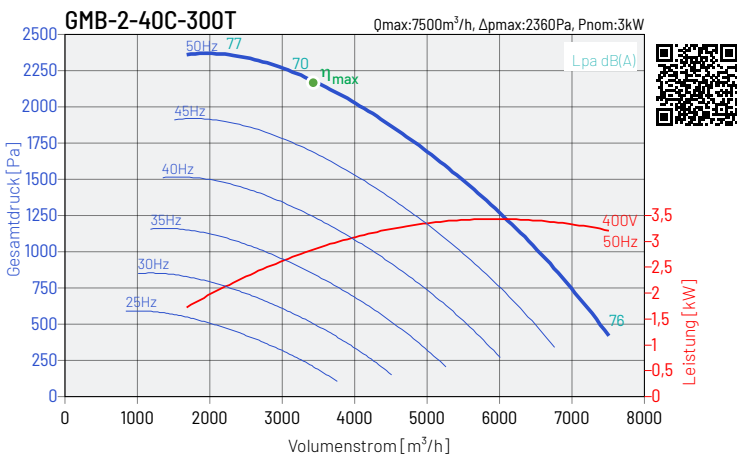

MC	EC	SR	VSD	$\eta\%$	N	kW	m ³ /h	Pa	rpm
C	statisch	1	nein	70,0	75,8	2,81	3 367	2 104	2 915

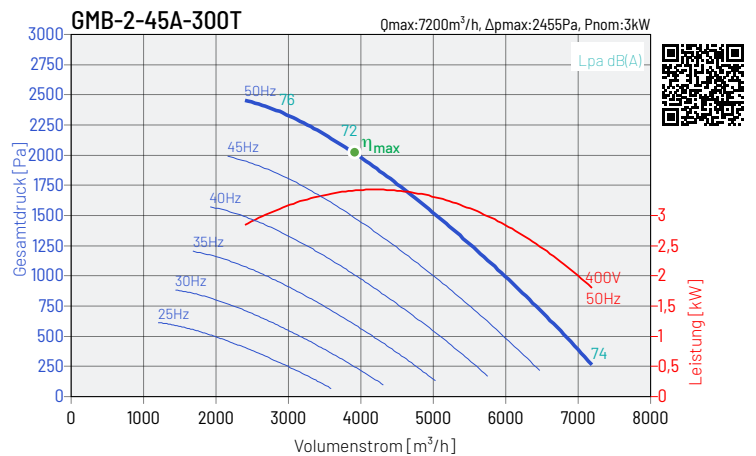

MC	EC	SR	VSD	$\eta\%$	N	kW	m ³ /h	Pa	rpm
C	statisch	1	nein	61,8	66,7	3,42	3 993	1 907	2 915

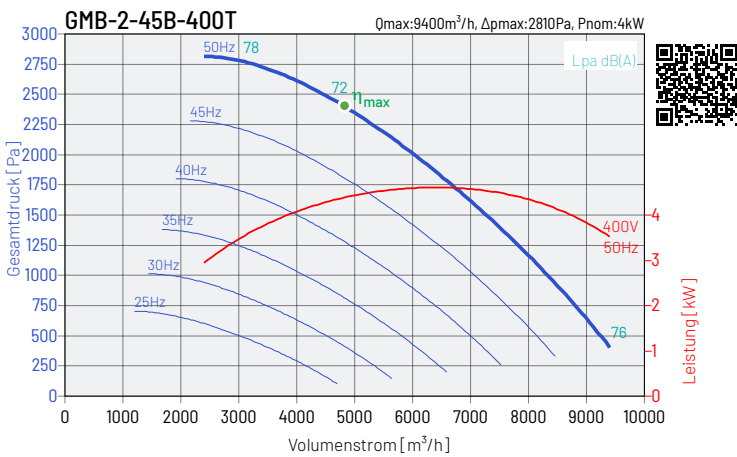

MC	EC	SR	VSD	$\eta\%$	N	kW	m ³ /h	Pa	rpm
C	statisch	1	nein	69,2	73,0	4,42	4 792	2 299	2 925

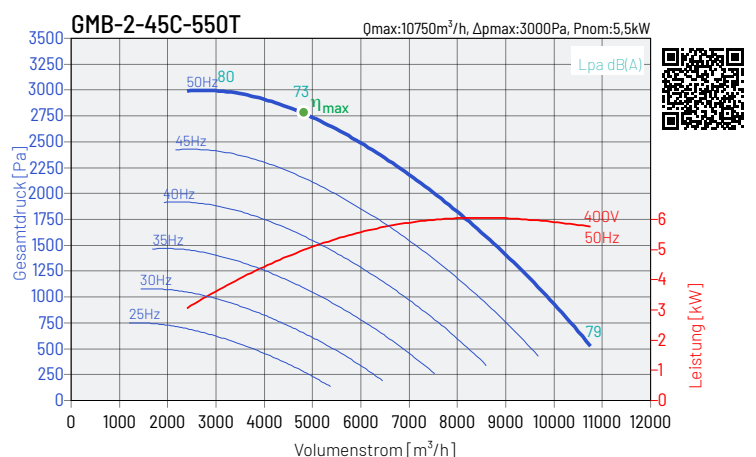

MC	EC	SR	VSD	$\eta\%$	N	kW	m ³ /h	Pa	rpm
C	statisch	1	nein	71,2	74,4	4,99	4 811	2 661	2 940

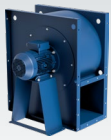

KENNLINIEN

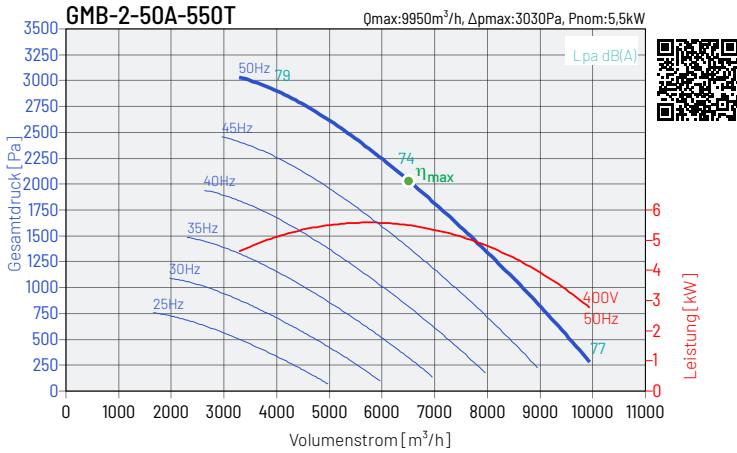

MC	EC	SR	VSD	$\eta\%$	N	kW	m³/h	Pa	rpm
C	statisch	1	nein	64,4	67,0	5,58	5 478	2 359	2 940

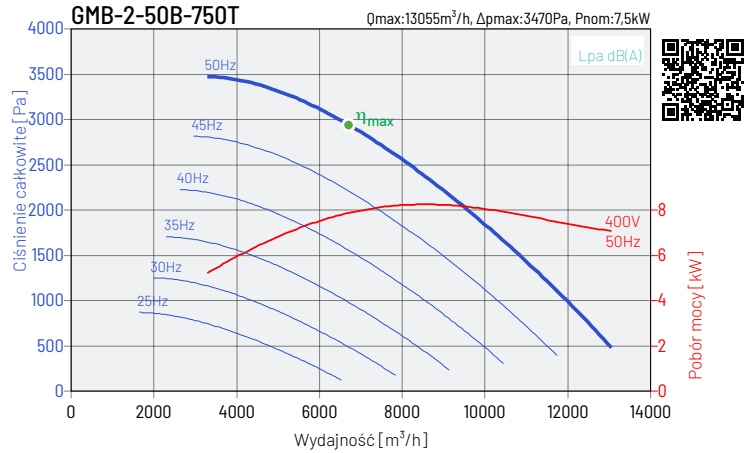

MC	EC	SR	VSD	$\eta\%$	N	kW	m³/h	Pa	rpm
C	statisch	1	nein	66,7	67,8	7,79	6 573	2 846	2 940

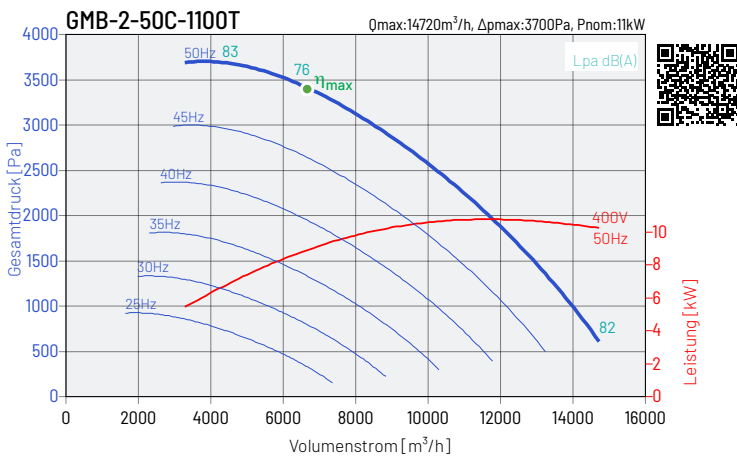

MC	EC	SR	VSD	$\eta\%$	N	kW	m³/h	Pa	rpm
C	statisch	1	nein	68,2	68,7	8,83	6 570	3 300	2 925

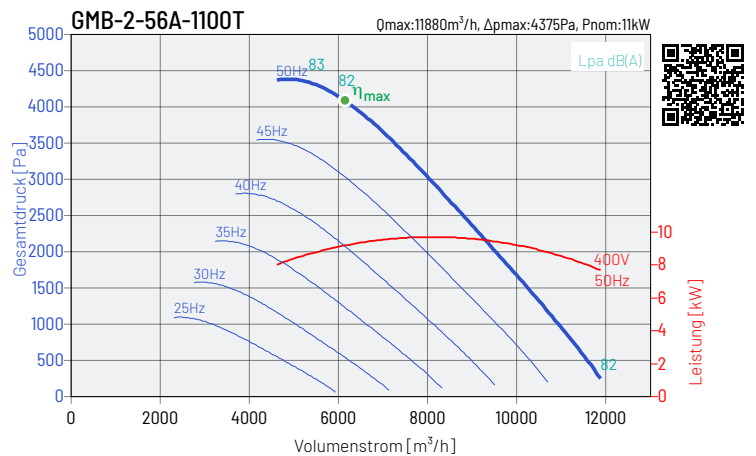

MC	EC	SR	VSD	$\eta\%$	N	kW	m³/h	Pa	rpm
C	statisch	1	nein	74,6	75,0	9,18	6 157	4 003	2 925

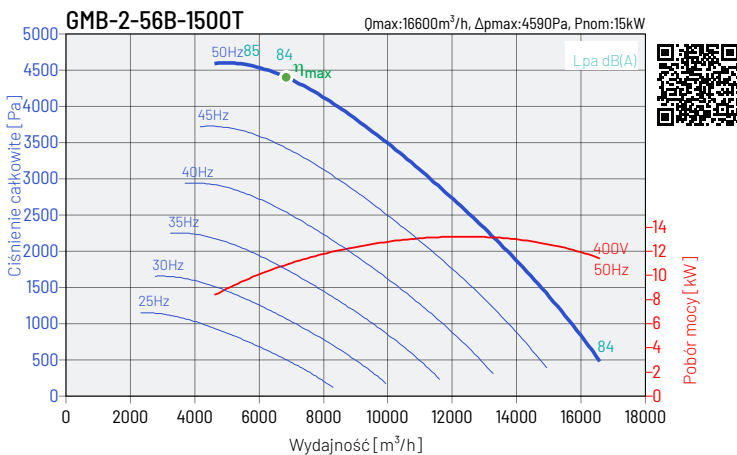

MC	EC	SR	VSD	$\eta\%$	N	kW	m³/h	Pa	rpm
C	statisch	1	nein	75,9	75,8	11,57	7 696	4 110	2 945

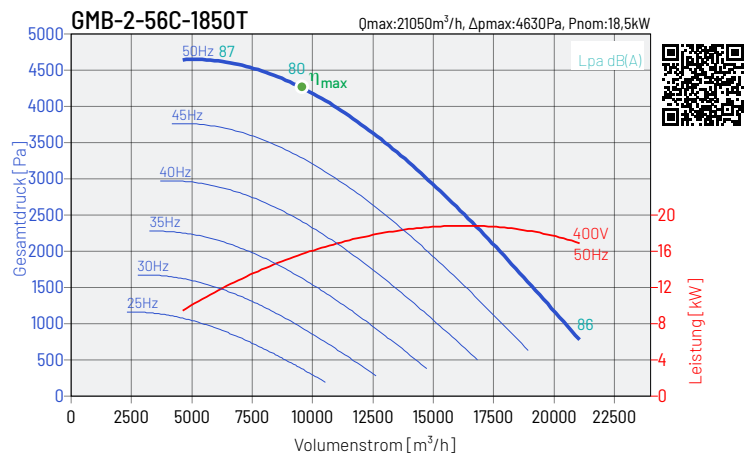

MC	EC	SR	VSD	$\eta\%$	N	kW	m³/h	Pa	rpm
C	statisch	1	nein	69,1	68,7	15,38	9 235	4 142	2 940

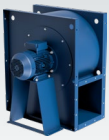

KENNLINIEN

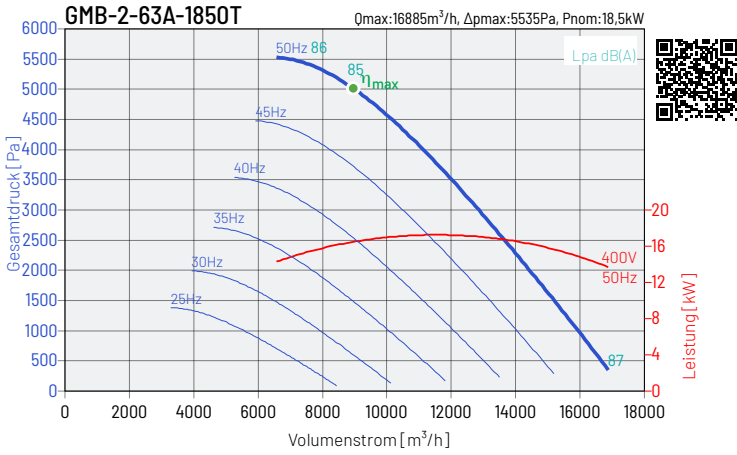

MC	EC	SR	VSD	$\eta\%$	N	kW	m³/h	Pa	rpm
C	statisch	1	nein	73,9	73,4	16,35	8 766	4 962	2 940

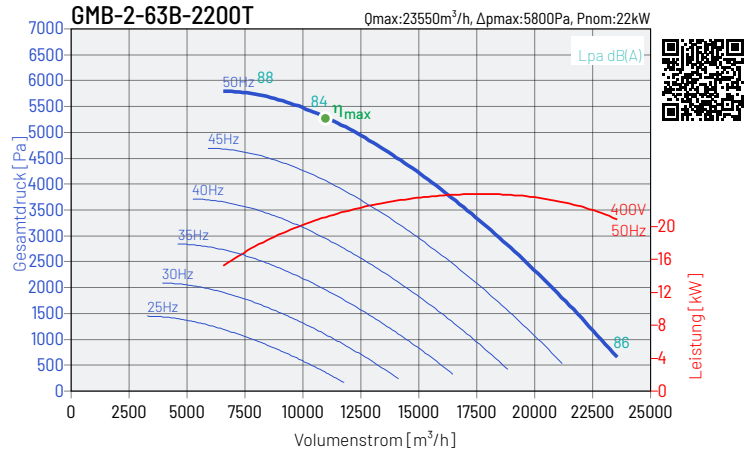

MC	EC	SR	VSD	$\eta\%$	N	kW	m³/h	Pa	rpm
C	statisch	1	nein	74,5	73,7	21,11	10 957	5 168	2 955

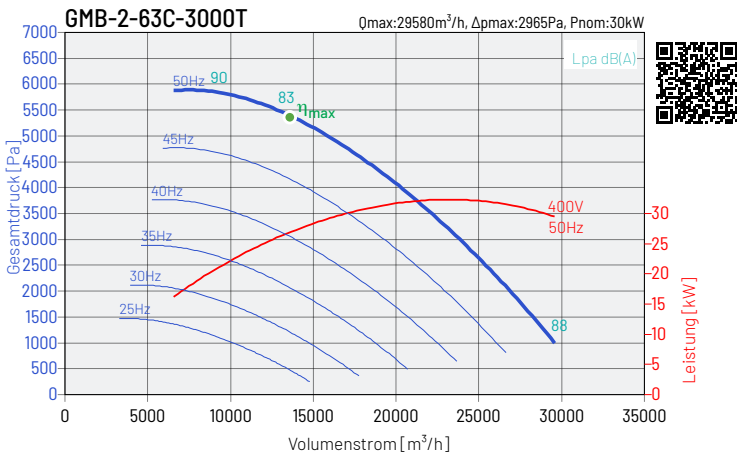

MC	EC	SR	VSD	$\eta\%$	N	kW	m³/h	Pa	rpm
C	statisch	1	nein	72,4	71,4	26,44	13 149	5 239	2 965

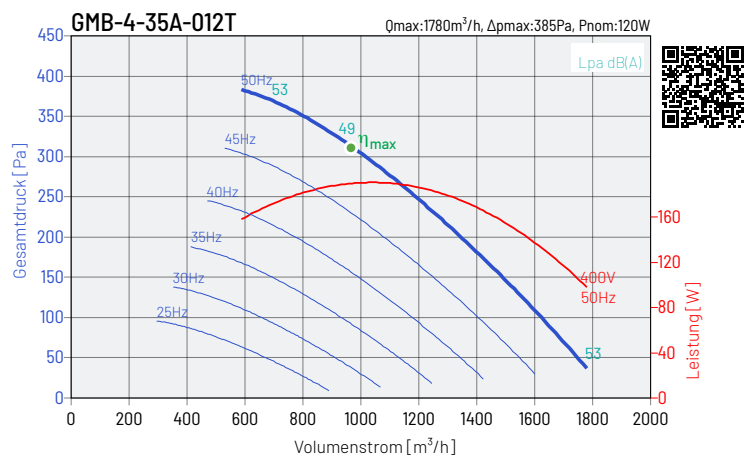

MC	EC	SR	VSD	$\eta\%$	N	kW	m³/h	Pa	rpm
C	statisch	1	nein	42,9	61,0	0,19	979	300	1400

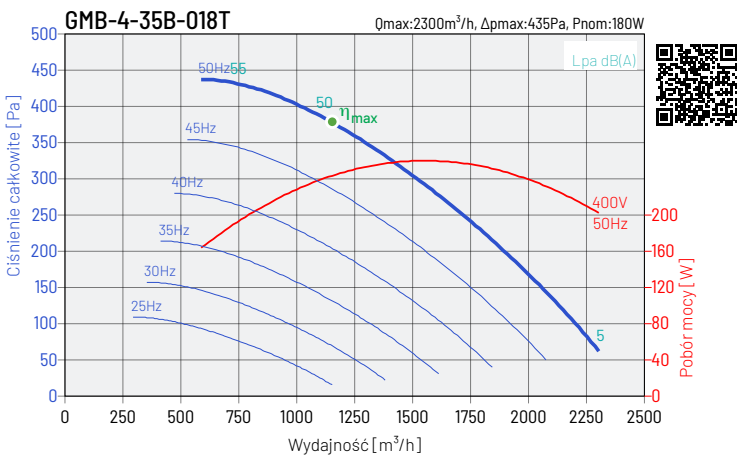

MC	EC	SR	VSD	$\eta\%$	N	kW	m³/h	Pa	rpm
C	statisch	1	nein	47,6	64,5	0,25	1176	357	1400

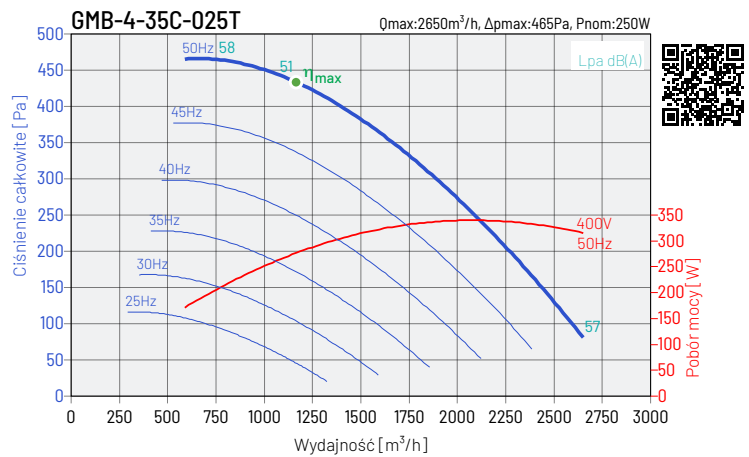

MC	EC	SR	VSD	$\eta\%$	N	kW	m³/h	Pa	rpm
C	statisch	1	nein	48,8	65,1	0,28	1176	415	1410

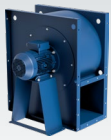

KENNLINIEN

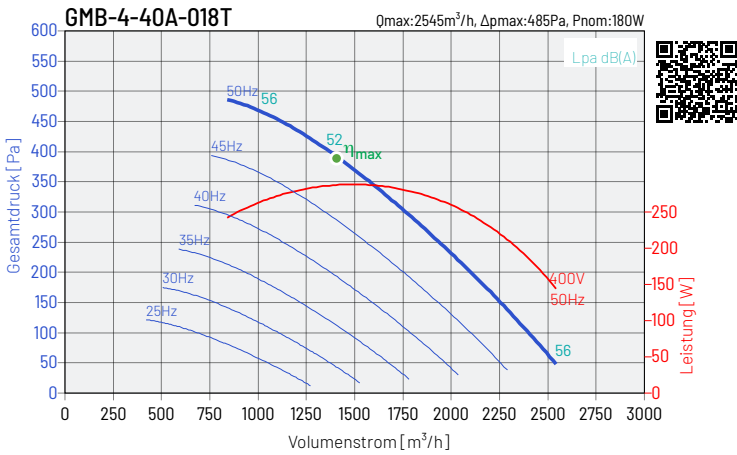

MC	EC	SR	VSD	η%	N	kW	m³/h	Pa	rpm
C	statisch	1	nein	51,7	67,9	0,29	1402	378	1400

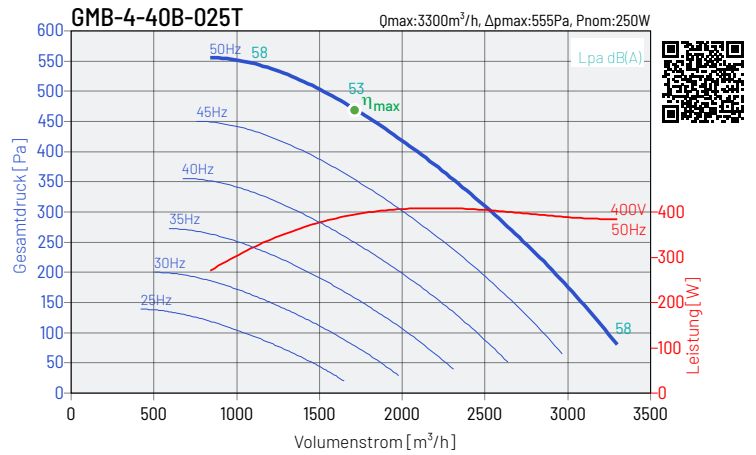

MC	EC	SR	VSD	η%	N	kW	m³/h	Pa	rpm
C	statisch	1	nein	54,0	68,8	0,39	1683	454	1410

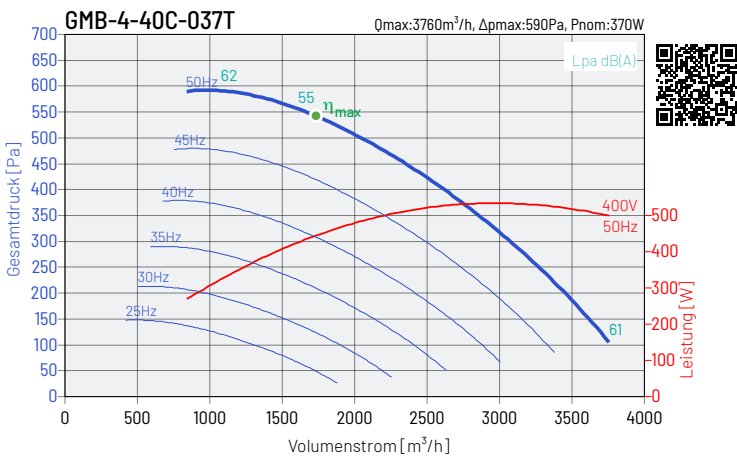

MC	EC	SR	VSD	η%	N	kW	m³/h	Pa	rpm
C	statisch	1	nein	55,9	70,2	0,44	1691	520	1410

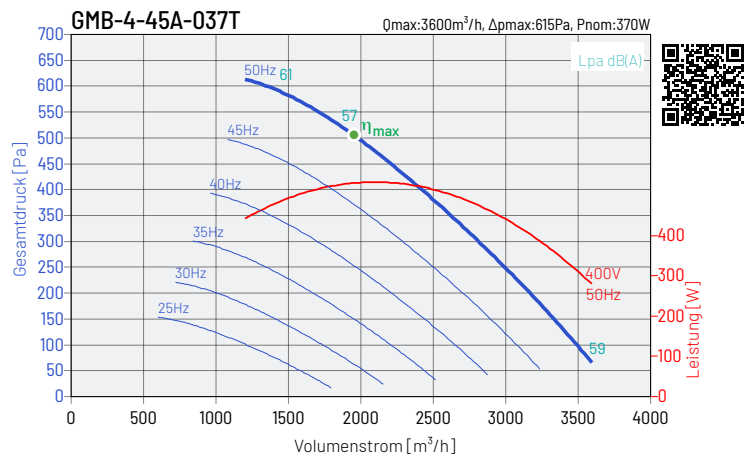

MC	EC	SR	VSD	η%	N	kW	m³/h	Pa	rpm
C	statisch	1	nein	49,7	63,1	0,53	1997	477	1410

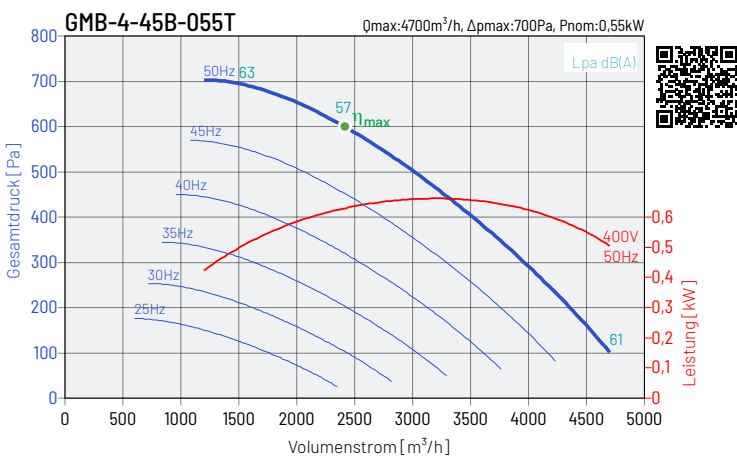

MC	EC	SR	VSD	η%	N	kW	m³/h	Pa	rpm
C	statisch	1	nein	60,4	72,9	0,63	2396	575	1420

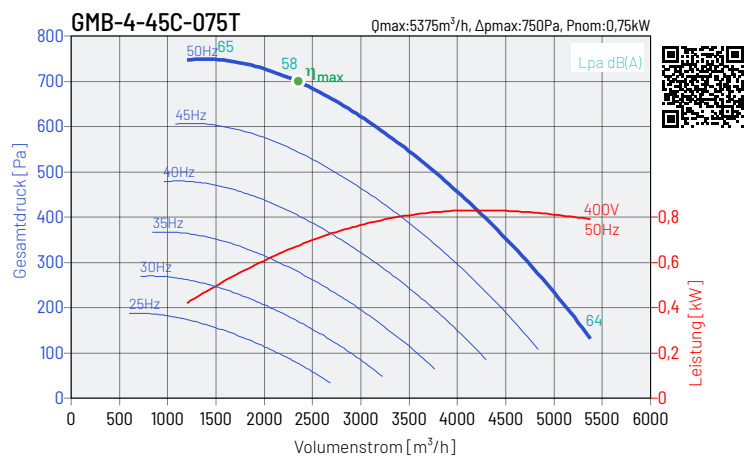

MC	EC	SR	VSD	η%	N	kW	m³/h	Pa	rpm
C	statisch	1	nein	64,8	77,0	0,68	2405	663	1430

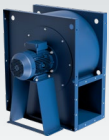

KENNLINIEN

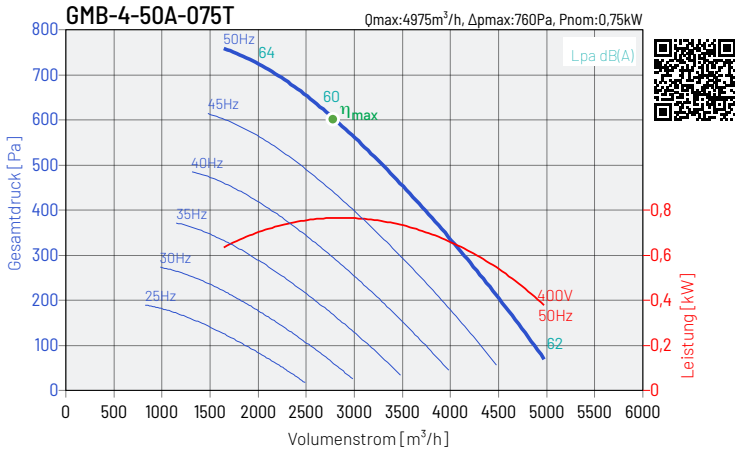

MC	EC	SR	VSD	$\eta\%$	N	kW	m ³ /h	Pa	rpm
C	statisch	1	nein	58,7	70,4	0,77	2 739	590	1430

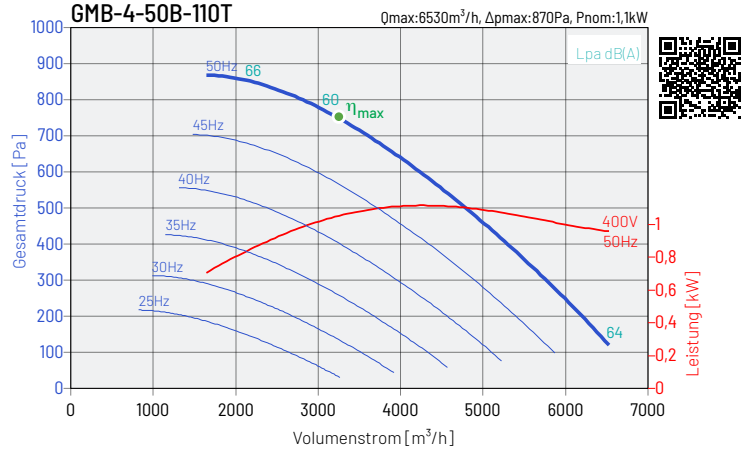

MC	EC	SR	VSD	$\eta\%$	N	kW	m ³ /h	Pa	rpm
C	statisch	1	nein	61,6	71,9	1,05	3 287	711	1450

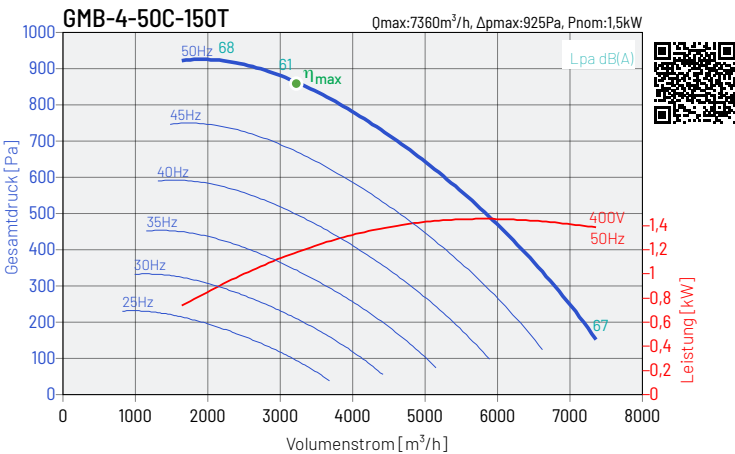

MC	EC	SR	VSD	$\eta\%$	N	kW	m ³ /h	Pa	rpm
C	statisch	1	nein	62,8	72,5	1,19	3 299	817	1450

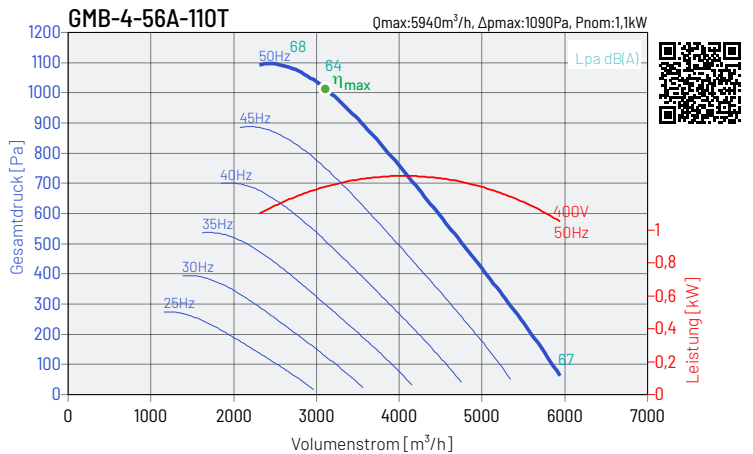

MC	EC	SR	VSD	$\eta\%$	N	kW	m ³ /h	Pa	rpm
C	statisch	1	nein	68,0	77,5	1,26	3 078	1001	1450

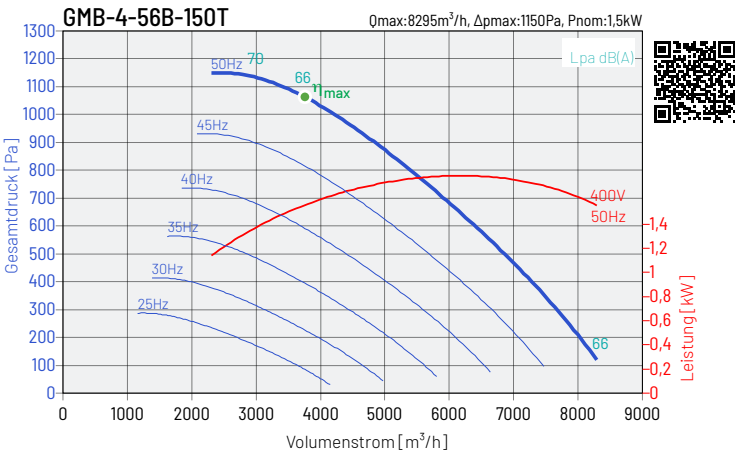

MC	EC	SR	VSD	$\eta\%$	N	kW	m ³ /h	Pa	rpm
C	statisch	1	nein	69,7	78,1	1,58	3 848	1028	1465

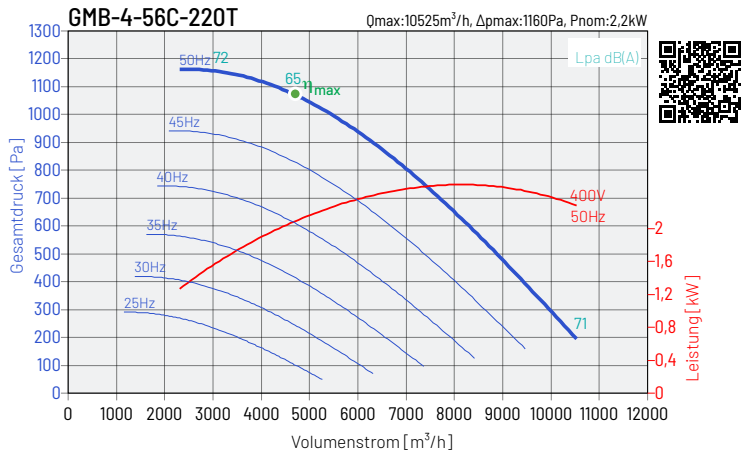

MC	EC	SR	VSD	$\eta\%$	N	kW	m ³ /h	Pa	rpm
C	statisch	1	nein	64,2	71,3	2,07	4 617	1035	1465

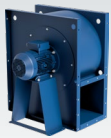

KENNLINIEN

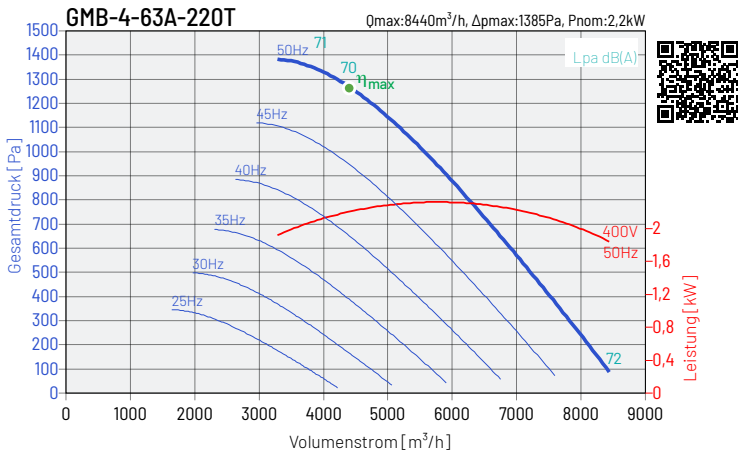

MC	EC	SR	VSD	$\eta\%$	N	kW	m³/h	Pa	rpm
C	statisch	1	nein	68,7	75,6	2,20	4 383	1241	1465

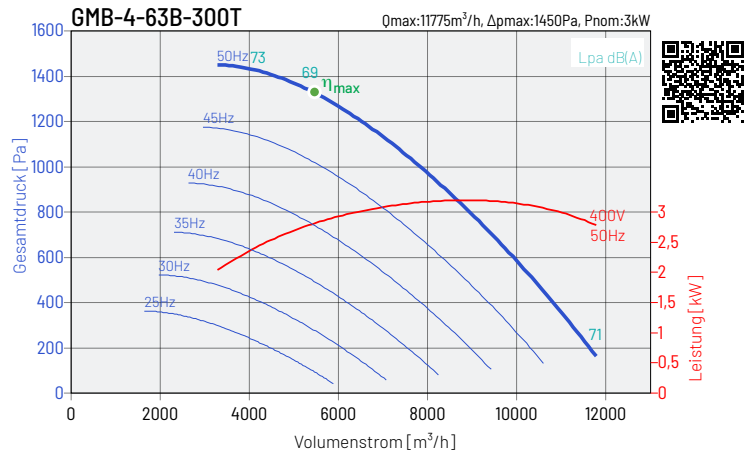

MC	EC	SR	VSD	$\eta\%$	N	kW	m³/h	Pa	rpm
C	statisch	1	nein	69,8	75,6	2,82	5 479	1292	1465

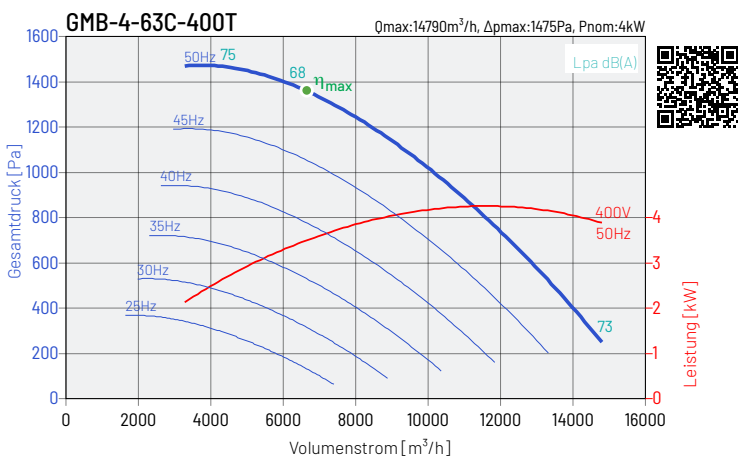

MC	EC	SR	VSD	$\eta\%$	N	kW	m³/h	Pa	rpm
C	statisch	1	nein	68,7	73,6	3,48	6 574	1310	1460

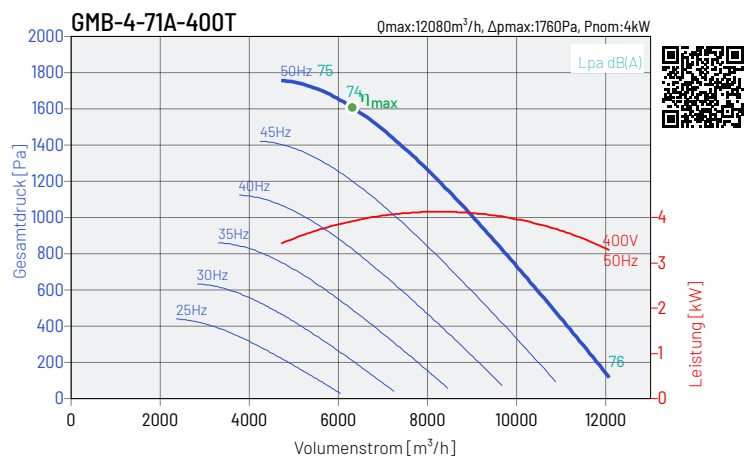

MC	EC	SR	VSD	$\eta\%$	N	kW	m³/h	Pa	rpm
C	statisch	1	nein	70,2	74,4	3,91	6 274	1575	1460

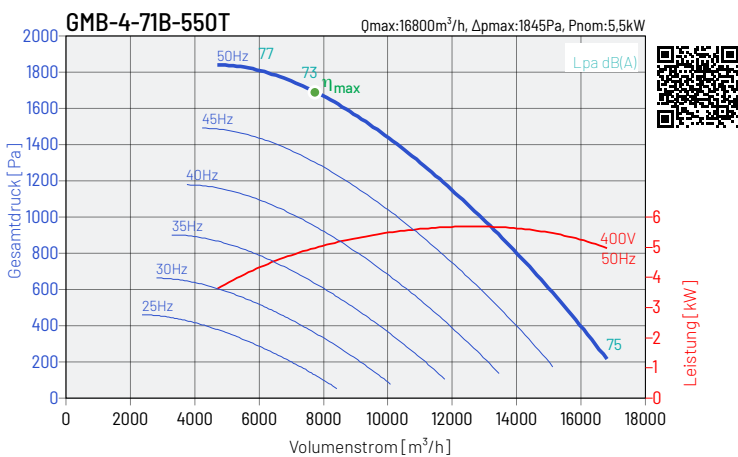

MC	EC	SR	VSD	$\eta\%$	N	kW	m³/h	Pa	rpm
C	statisch	1	nein	71,3	74,4	5,01	7 842	1640	1460

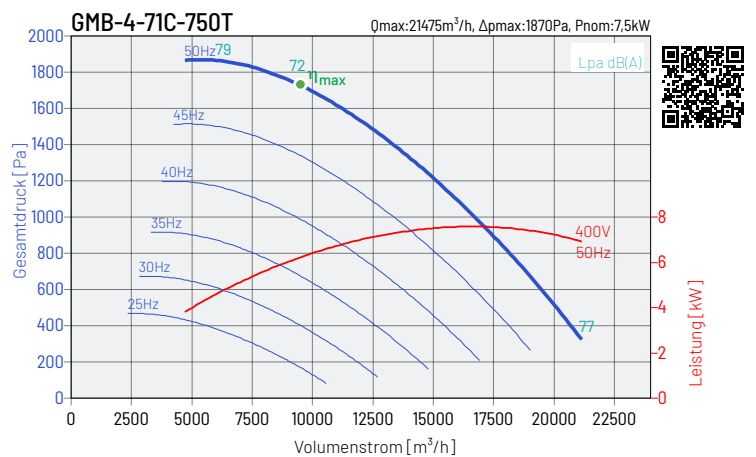

MC	EC	SR	VSD	$\eta\%$	N	kW	m³/h	Pa	rpm
C	statisch	1	nein	70,1	72,2	6,20	9 410	1662	1465

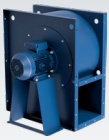

KENNLINIEN

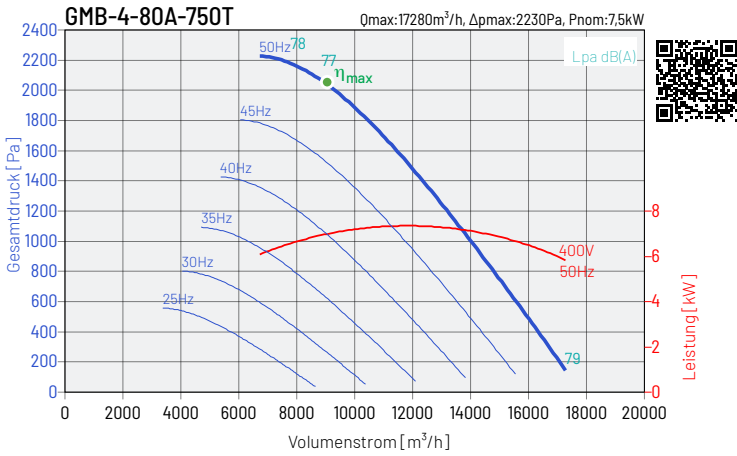

MC	EC	SR	VSD	$\eta\%$	N	kW	m³/h	Pa	rpm
C	statisch	1	nein	71,6	73,2	6,96	8 975	1 999	1 465

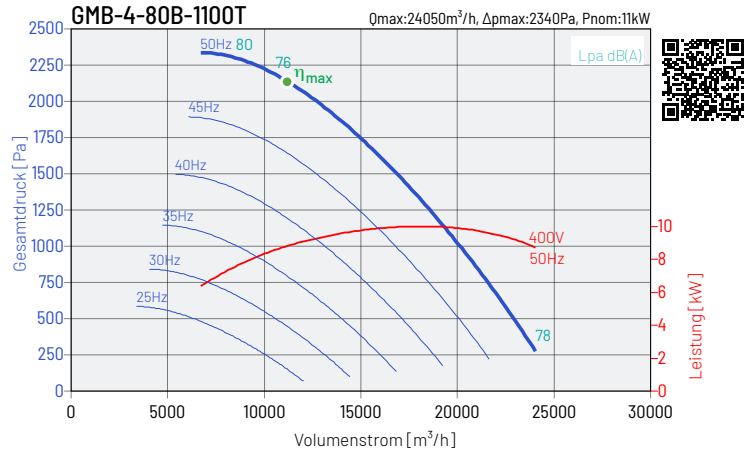

MC	EC	SR	VSD	$\eta\%$	N	kW	m³/h	Pa	rpm
C	statisch	1	nein	73,6	74,1	8,82	11 218	2 082	1 460

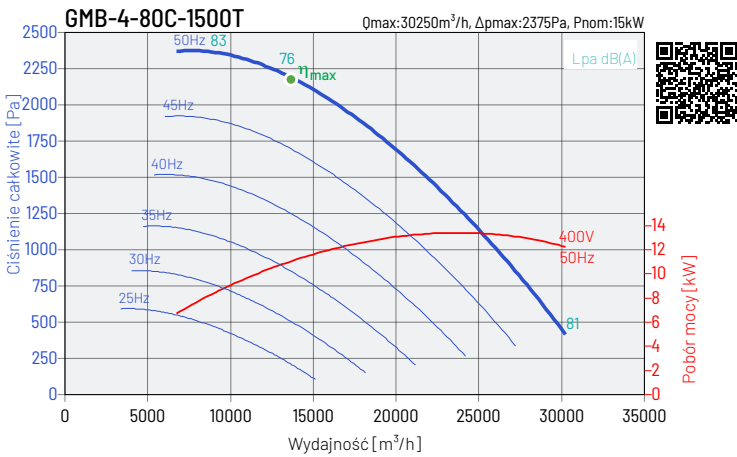

MC	EC	SR	VSD	$\eta\%$	N	kW	m³/h	Pa	rpm
C	statisch	1	nein	72,3	72,3	10,91	13 462	2 109	1 475

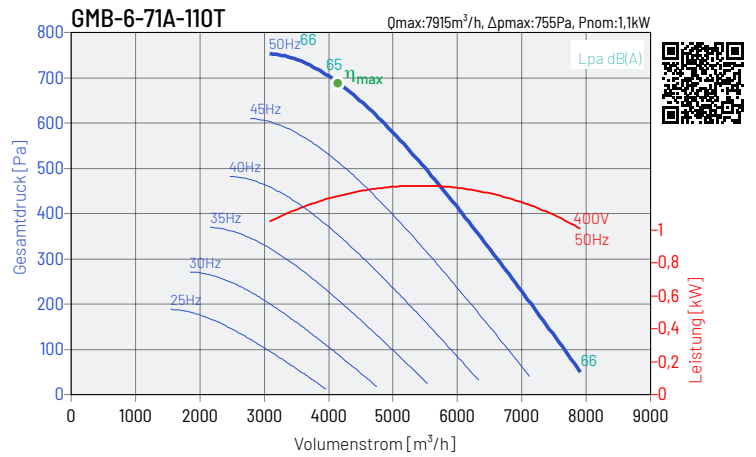

MC	EC	SR	VSD	$\eta\%$	N	kW	m³/h	Pa	rpm
C	statisch	1	nein	64,2	73,9	1,20	4 109	676	940

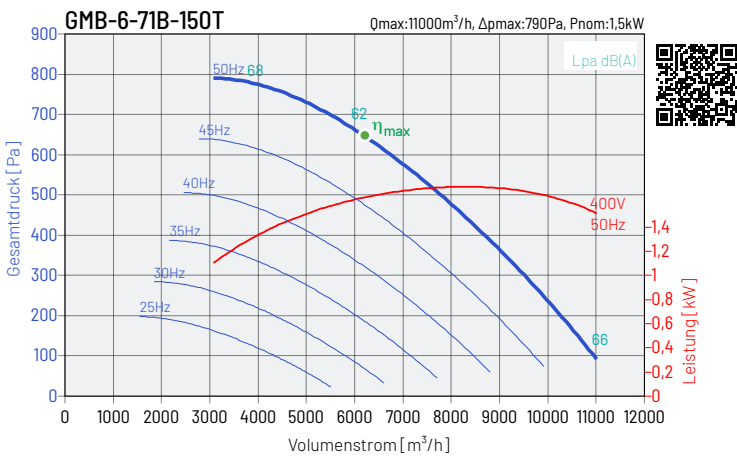

MC	EC	SR	VSD	$\eta\%$	N	kW	m³/h	Pa	rpm
C	statisch	1	nein	65,7	74,2	1,53	5 137	704	960

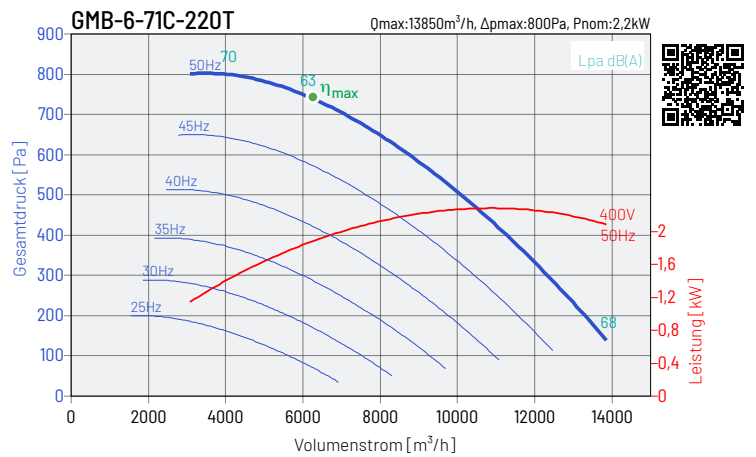

MC	EC	SR	VSD	$\eta\%$	N	kW	m³/h	Pa	rpm
C	statisch	1	nein	65,4	73,0	1,87	6 164	713	965

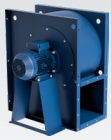

KENNLINIEN

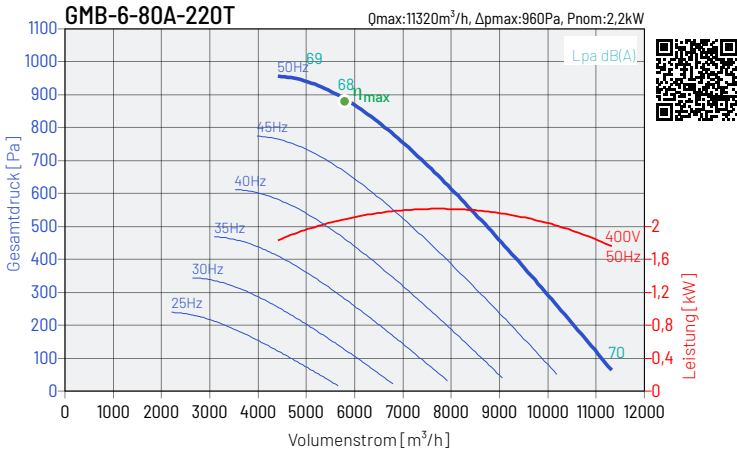

MC	EC	SR	VSD	$\eta\%$	N	kW	m^3/h	Pa	rpm
C	statisch	1	nein	66,8	73,9	2,10	5 878	858	965

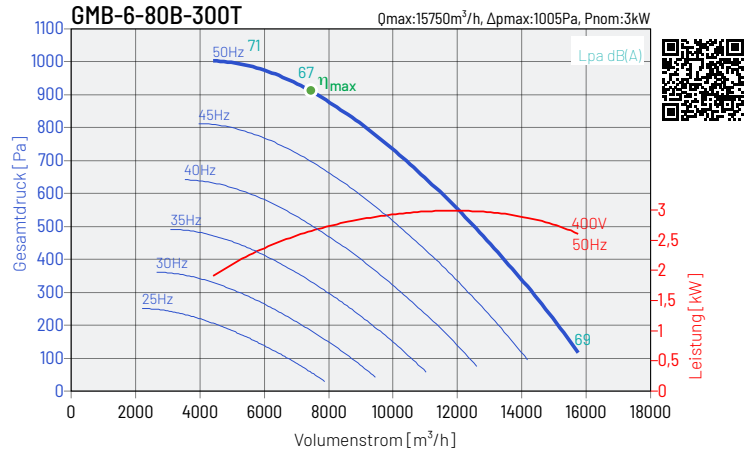

MC	EC	SR	VSD	$\eta\%$	N	kW	m^3/h	Pa	rpm
C	statisch	1	nein	69,2	75,3	2,64	7 348	893	965

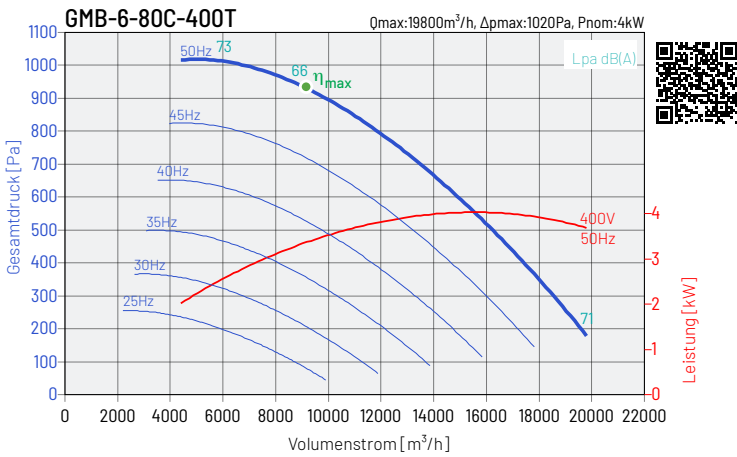

MC	EC	SR	VSD	$\eta\%$	N	kW	m^3/h	Pa	rpm
C	statisch	1	nein	67,2	72,3	3,30	8 817	905	965

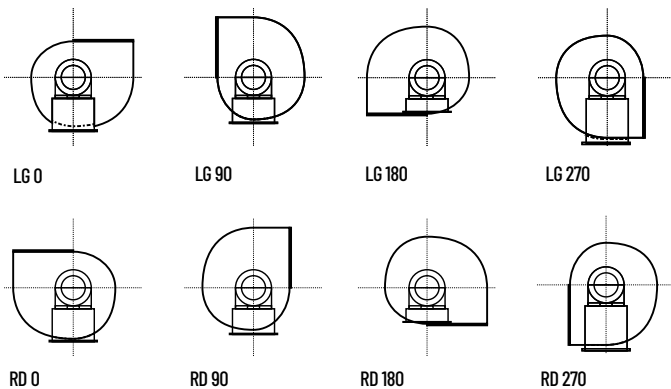

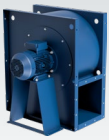

ABMESSUNGEN - FIGUR LG90

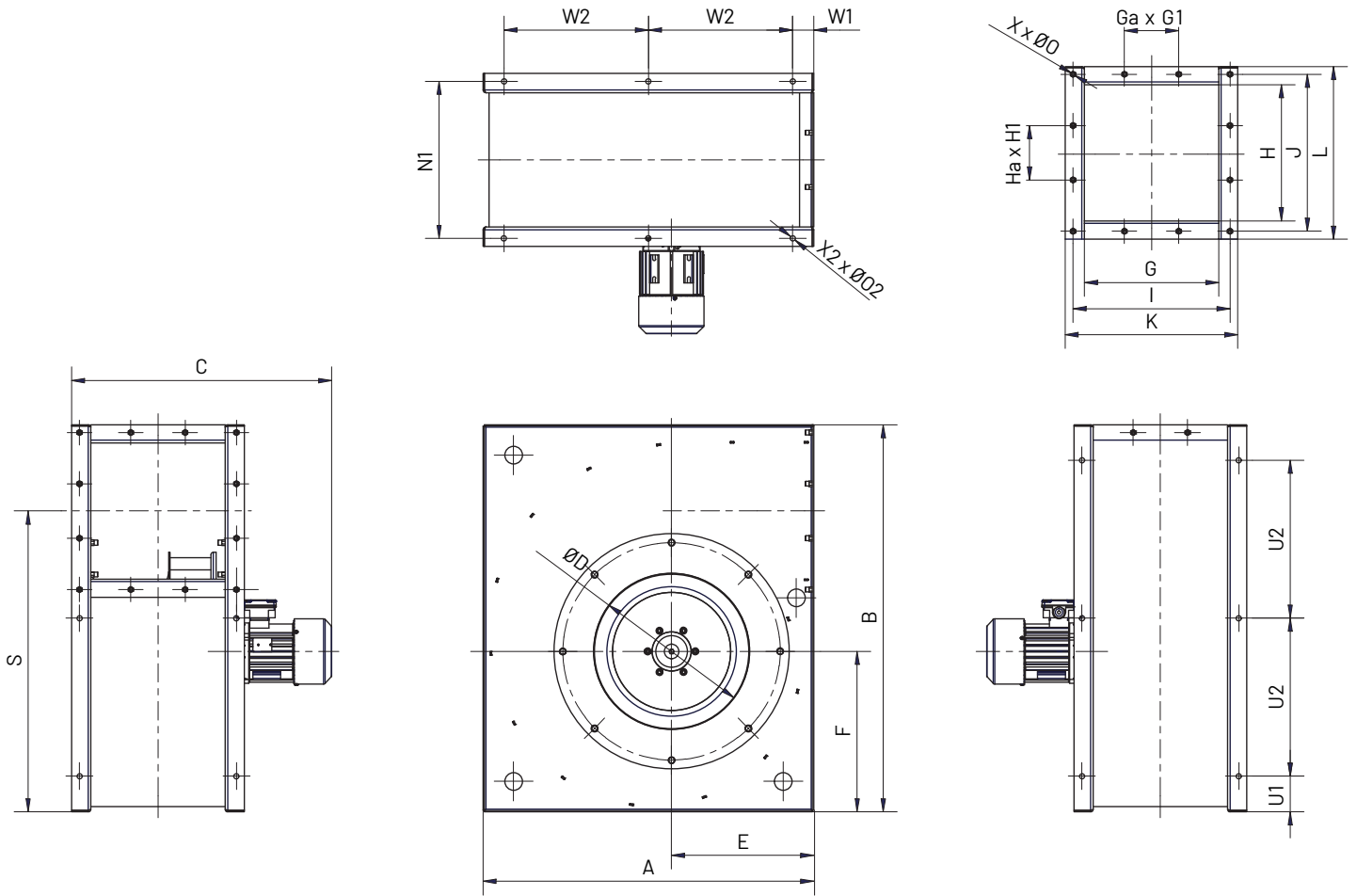

Typ	A mm	B mm	C* mm	ØD mm	ØD1 mm	E mm	F mm	G mm	Ga mm	G1 mm	H mm	Ha mm	H1 mm	I mm	J mm	K mm
FIGUR LG90																
GMB-X-25 LG90	425	505	395	200	300	177	212	175	1	100	175	1	100	216	216	229
GMB-X-28 LG90	475	565	474	225	325	202	236	200	1	100	200	1	100	236	236	262
GMB-X-31 LG90	535	630	520	253	350	227	263	216	1	100	222	1	100	260	260	286
GMB-X-35 LG90	600	705	579	283	400	257	295	244	1	125	248	1	125	286	286	312
GMB-X-40 LG90	675	790	592	318	460	287	332	274	1	125	278	1	125	326	326	362
GMB-X-45 LG90	760	890	626	358	500	327	369	309	1	125	313	1	125	361	361	397
GMB-X-50 LG90	840	990	694	404	550	357	416	349	1	125	353	1	125	401	401	437
GMB-X-56 LG90	940	1110	738	454	620	397	472	394	1	125	398	1	125	446	446	482
GMB-X-71 LG90	1190	1390	830	564	790	507	588	492	3	125	498	3	125	546	546	586

* Maß für die längste Motorausführung (abhängig vom Motorhersteller)

Typ	L mm	N1 mm	N2* mm	N3* mm	P mm	S mm	U1 mm	U2 mm	W1 mm	W2 mm	X mm	Ø0 mm	X1 mm	Ø1 mm	X2 mm	Ø2 mm
FIGUR LG90																
GMB-X-25 LG90	229	216	-	-	-	391	82	341	48	329	12	M6	8	M6	4	10
GMB-X-28 LG90	262	236	-	-	-	434	82	401	48	379	12	M6	8	M6	4	10
GMB-X-31 LG90	286	260	-	-	-	487	82	466	48	439	12	M8	8	M6	6	10
GMB-X-35 LG90	312	286	-	-	-	549	82	541	48	504	12	M8	8	M6	6	10
GMB-X-40 LG90	362	326	-	-	-	609	82	313	48	290	12	M8	8	M8	6	10
GMB-X-45 LG90	397	361	-	-	-	692	82	363	48	332	12	M8	8	M8	6	12
GMB-X-50 LG90	437	401	-	-	-	772	82	413	48	372	12	M10	12	M8	6	12
GMB-X-56 LG90	482	446	-	-	-	869	82	473	48	422	12	M10	12	M8	6	12
GMB-X-71 LG90	590	546	-	-	-	1095	82	613	82	513	20	M12	12	M10	6	14

* Maß für die längste Motorausführung (abhängig vom Motorhersteller)

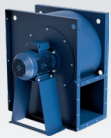

ABMESSUNGEN - FIGUR LG270

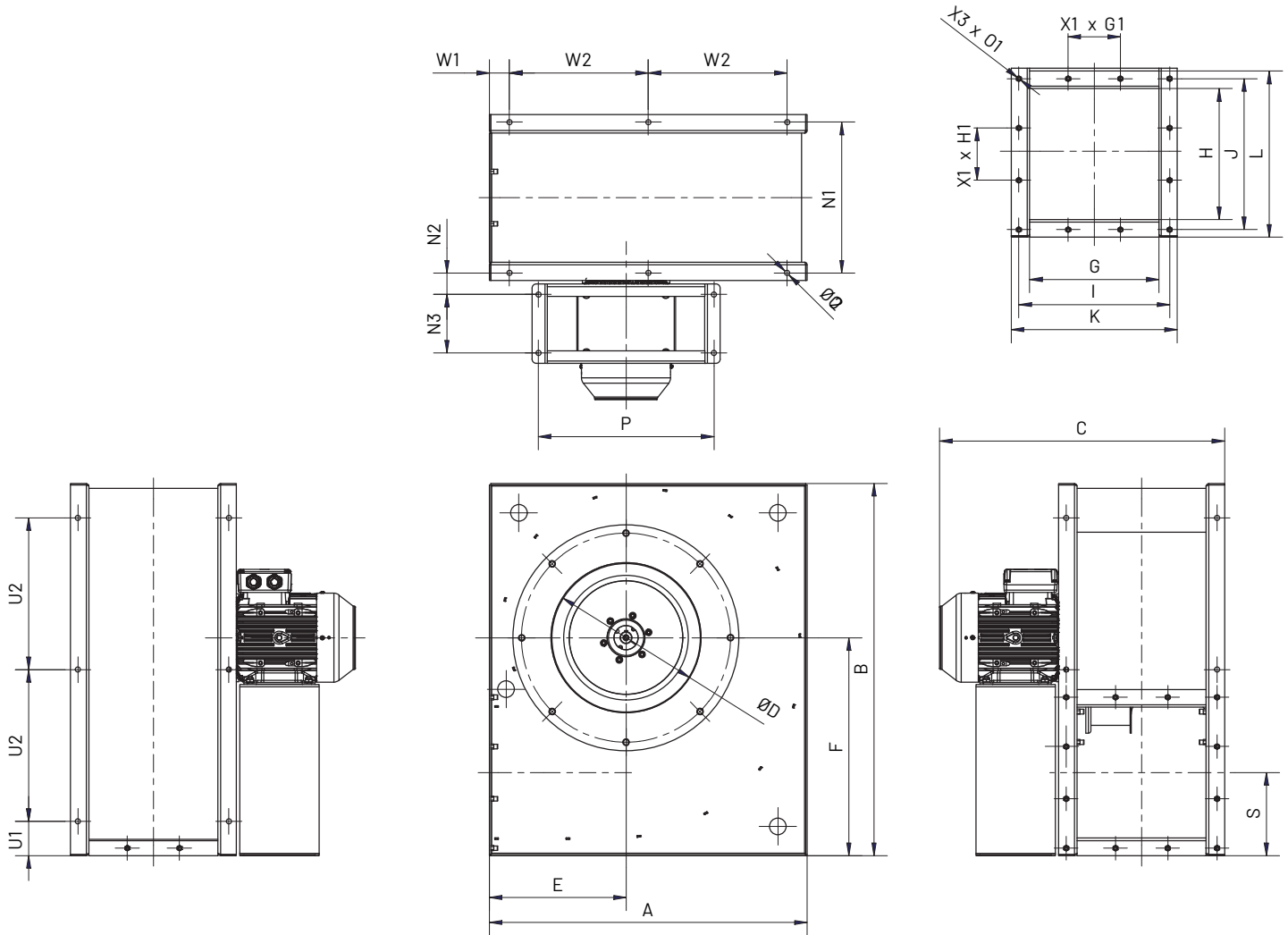

Typ	A mm	B mm	C* mm	ØD mm	ØD1 mm	E mm	F mm	G mm	Ga mm	G1 mm	H mm	Ha mm	H1 mm	I mm	J mm	K mm
FIGUR LG270																
GMB-X-45 LG270	760	890	742	358	500	327	521	309	1	125	313	1	125	361	361	397
GMB-X-50 LG270	840	990	890	404	550	357	575	349	1	125	353	1	125	401	401	437
GMB-X-56 LG270	940	1110	935	454	620	397	638	394	1	125	398	1	125	446	446	482
GMB-X-63 LG270	1060	1230	1167	504	700	447	713	444	3	125	448	3	125	496	496	532
GMB-X-71 LG270	1190	1390	954	564	790	507	802	492	3	125	498	3	125	546	546	586
GMB-X-80 LG270	1350	1560	1099	634	880	580	898	552	3	125	558	3	125	606	606	646

* Maß für die längste Motorausführung (abhängig vom Motorhersteller)

Typ	L mm	N1 mm	N2* mm	N3* mm	P mm	S mm	U1 mm	U2 mm	W1 mm	W2 mm	X mm	Ø0 mm	X1 mm	Ø01 mm	X2 mm	Ø02 mm
FIGUR LG270																
GMB-X-45 LG270	361	51	140	420	199	82	363	48	332	329	12	M8	8	M8	6	12
GMB-X-50 LG270	401	51	160	500	219	82	413	48	372	379	12	M10	12	M8	6	12
GMB-X-56 LG270	446	51	180	540	241	82	473	48	422	439	12	M10	12	M8	6	12
GMB-X-63 LG270	496	51	200	560	266	82	533	48	482	504	20	M10	12	M10	6	12
GMB-X-71 LG270	546	58	130	560	295	82	513	82	613	290	20	M8	12	M10	6	14
GMB-X-80 LG270	606	58	150	580	325	82	698	82	593	332	20	M12	16	M10	6	14

* Maß für die längste Motorausführung (abhängig vom Motorhersteller)

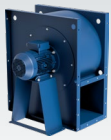

MONTAGEZUBEHÖR

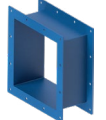
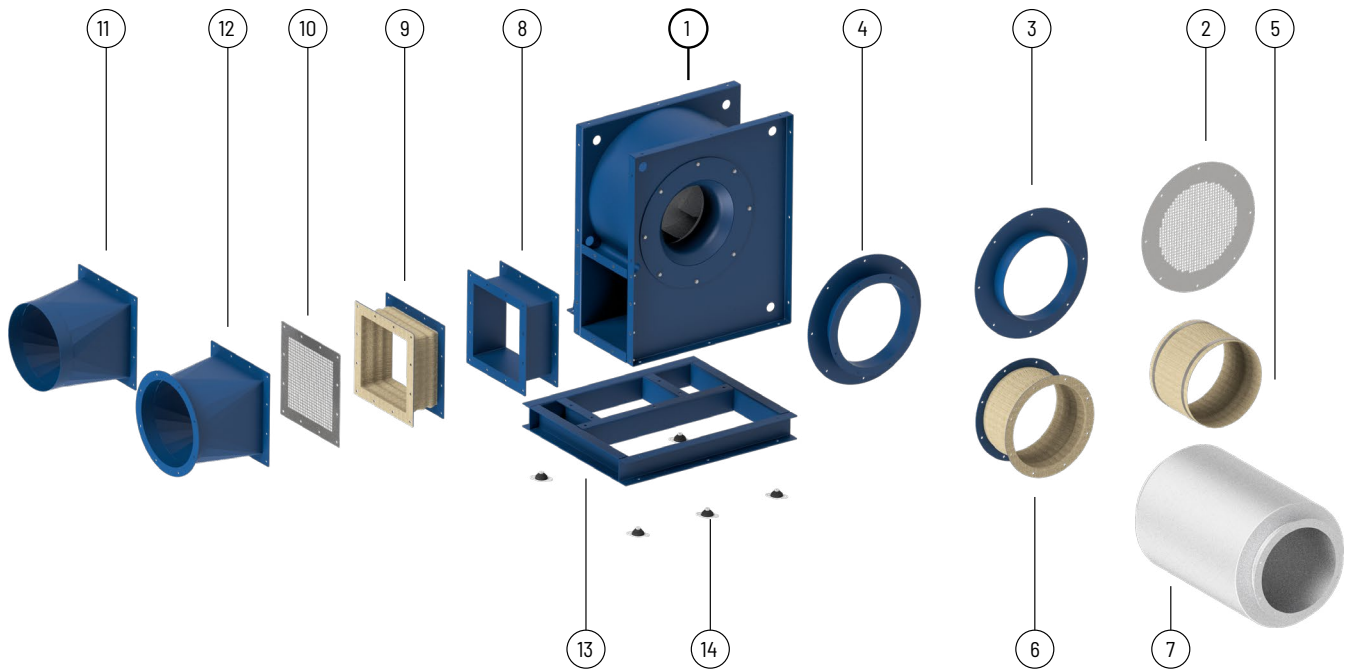

1

2

3

4

5

6

7

8

Typ	Einlassschutz Schutzgitter	Einlass Verbinder	Verbinder mit Flansch	Flexibler Verbinder Anschluss	Flexibler Verbinder Anschluss mit Flansch	Dämpfer	Rechteckiger Ausgangsanschluss
GMB-2-25	SW GMB-250	KW GMB-250	KWK GMB-250	ZPO GMB-250	ZPOK GMB-250	Dämpfer GMB-250	KWP GMB-250
GMB-2-28	SW GMB-280	KW GMB-280	KWK GMB-280	ZPO GMB-280	ZPOK GMB-280	Dämpfer GMB-280	KWP GMB-280
GMB-2-31	SW GMB-315	KW GMB-315	KWK GMB-315	ZPO GMB-315	ZPOK GMB-315	Dämpfer GMB-315	KWP GMB-315
GMB-2-35	SW GMB-355	KW GMB-355	KWK GMB-355	ZPO GMB-355	ZPOK GMB-355	Dämpfer GMB-355	KWP GMB-355
GMB-2-40	SW GMB-400	KW GMB-400	KWK GMB-400	ZPO GMB-400	ZPOK GMB-400	Dämpfer GMB-400	KWP GMB-400
GMB-2-45	SW GMB-450	KW GMB-450	KWK GMB-450	ZPO GMB-450	ZPOK GMB-450	Dämpfer GMB-450	KWP GMB-450
GMB-2-50	SW GMB-500	KW GMB-500	KWK GMB-500	ZPO GMB-500	ZPOK GMB-500	Dämpfer GMB-500	KWP GMB-500
GMB-2-56	SW GMB-560	KW GMB-560	KWK GMB-560	ZPO GMB-560	ZPOK GMB-560	Dämpfer GMB-560	KWP GMB-560
GMB-2-63	SW GMB-630	KW GMB-630	KWK GMB-630	ZPO GMB-630	ZPOK GMB-630	Dämpfer GMB-630	KWP GMB-630
GMB-4-35	SW GMB-355	KW GMB-355	KWK GMB-355	ZPO GMB-355	ZPOK GMB-355	Dämpfer GMB-355	KWP GMB-355
GMB-4-40	SW GMB-400	KW GMB-400	KWK GMB-400	ZPO GMB-400	ZPOK GMB-400	Dämpfer GMB-400	KWP GMB-400
GMB-4-45	SW GMB-450	KW GMB-450	KWK GMB-450	ZPO GMB-450	ZPOK GMB-450	Dämpfer GMB-450	KWP GMB-450
GMB-4-50	SW GMB-500	KW GMB-500	KWK GMB-500	ZPO GMB-500	ZPOK GMB-500	Dämpfer GMB-500	KWP GMB-500
GMB-4-56	SW GMB-560	KW GMB-560	KWK GMB-560	ZPO GMB-560	ZPOK GMB-560	Dämpfer GMB-560	KWP GMB-560
GMB-4-63	SW GMB-630	KW GMB-630	KWK GMB-630	ZPO GMB-630	ZPOK GMB-630	Dämpfer GMB-630	KWP GMB-630
GMB-4-71	SW GMB-710	KW GMB-710	KWK GMB-710	ZPO GMB-710	ZPOK GMB-710	Dämpfer GMB-710	KWP GMB-710
GMB-4-80	SW GMB-800	KW GMB-800	KWK GMB-800	ZPO GMB-800	ZPOK GMB-800	Dämpfer GMB-800	KWP GMB-800
GMB-6-71	SW GMB-710	KW GMB-710	KWK GMB-710	ZPO GMB-710	ZPOK GMB-710	Dämpfer GMB-710	KWP GMB-710
GMB-6-80	SW GMB-800	KW GMB-800	KWK GMB-800	ZPO GMB-800	ZPOK GMB-800	Dämpfer GMB-800	KWP GMB-800

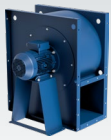

MONTAGEZUBEHÖR



1

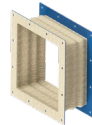

9

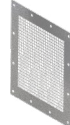

10

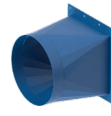

11

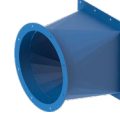

12



13



14

Typ	Rechteckiger Flexibler Verbinders Anschluss	Schützendes Auslassnetz	Reduktion	Reduktion mit Flansch	Rahmen	Vibrations isolator
GMB-2-25	ZPP GMB-250	SWY GMB-250	R GMB-250	RK GMB-250	-	4 x AVM-20
GMB-2-28	ZPP GMB-280	SWY GMB-280	R GMB-280	RK GMB-280	-	4 x AVM-20
GMB-2-31	ZPP GMB-315	SWY GMB-315	R GMB-315	RK GMB-315	-	4 x AVM-20
GMB-2-35	ZPP GMB-355	SWY GMB-355	R GMB-355	RK GMB-355	-	4 x AVM-20
GMB-2-40	ZPP GMB-400	SWY GMB-400	R GMB-400	RK GMB-400	-	4 x AVM-20
GMB-2-45	ZPP GMB-450	SWY GMB-450	R GMB-450	RK GMB-450	Rahmen GMB-450	6 x AVM-35
GMB-2-50	ZPP GMB-500	SWY GMB-500	R GMB-500	RK GMB-500	Rahmen GMB-500	6 x AVM-35
GMB-2-56	ZPP GMB-560	SWY GMB-560	R GMB-560	RK GMB-560	Rahmen GMB-560	6 x AVM-140
GMB-2-63	ZPP GMB-630	SWY GMB-630	R GMB-630	RK GMB-630	Rahmen GMB-630	6 x AVM-140
GMB-4-35	ZPP GMB-355	SWY GMB-355	R GMB-355	RK GMB-355	-	4 x AVM-20
GMB-4-40	ZPP GMB-400	SWY GMB-400	R GMB-400	RK GMB-400	-	4 x AVM-20
GMB-4-45	ZPP GMB-450	SWY GMB-450	R GMB-450	RK GMB-450	-	6 x AVM-20
GMB-4-50	ZPP GMB-500	SWY GMB-500	R GMB-500	RK GMB-500	-	6 x AVM-20
GMB-4-56	ZPP GMB-560	SWY GMB-560	R GMB-560	RK GMB-560	Rahmen GMB-560	6 x AVM-35
GMB-4-63	ZPP GMB-630	SWY GMB-630	R GMB-630	RK GMB-630	Rahmen GMB-630	6 x AVM-35
GMB-4-71	ZPP GMB-710	SWY GMB-710	R GMB-710	RK GMB-710	Rahmen GMB-710	6 x AVM-140
GMB-4-80	ZPP GMB-800	SWY GMB-800	R GMB-800	RK GMB-800	Rahmen GMB-800	6 x AVM-140
GMB-6-71	ZPP GMB-710	SWY GMB-710	R GMB-710	RK GMB-710	Rahmen GMB-710	6 x AVM-140
GMB-6-80	ZPP GMB-800	SWY GMB-800	R GMB-800	RK GMB-800	Rahmen GMB-800	6 x AVM-140

Artikelnummer

40542800 SW GMB-250	40542841 KWK GMB-250	40542881 ZPOK GMB-250	40542852 KWP GMB-250	40542811 SWY GMB-250	40542911 RK GMB-250
40542801 SW GMB-280	40542842 KWK GMB-280	40542882 ZPOK GMB-280	40542853 KWP GMB-280	40542812 SWY GMB-280	40542912 RK GMB-280
40542802 SW GMB-315	40542843 KWK GMB-315	40542883 ZPOK GMB-315	40542854 KWP GMB-315	40542813 SWY GMB-315	40542913 RK GMB-315
40542803 SW GMB-355	40542844 KWK GMB-355	40542884 ZPOK GMB-355	40542855 KWP GMB-355	40542814 SWY GMB-355	40542914 RK GMB-355
40542804 SW GMB-400	40542845 KWK GMB-400	40542885 ZPOK GMB-400	40542856 KWP GMB-400	40542815 SWY GMB-400	40542915 RK GMB-400
40542805 SW GMB-450	40542846 KWK GMB-450	40542886 ZPOK GMB-450	40542857 KWP GMB-450	40542816 SWY GMB-450	40542916 RK GMB-450
40542806 SW GMB-500	40542847 KWK GMB-500	40542887 ZPOK GMB-500	40542858 KWP GMB-500	40542817 SWY GMB-500	40542917 RK GMB-500
40542807 SW GMB-560	40542848 KWK GMB-560	40542888 ZPOK GMB-560	40542859 KWP GMB-560	40542818 SWY GMB-560	40542918 RK GMB-560
40542808 SW GMB-630	40542849 KWK GMB-630	40542889 ZPOK GMB-630	40542860 KWP GMB-630	40542819 SWY GMB-630	40542919 RK GMB-630
40542809 SW GMB-710	40542850 KWK GMB-710	40542890 ZPOK GMB-710	40542861 KWP GMB-710	40542820 SWY GMB-710	40542920 RK GMB-710
40542810 SW GMB-800	40542851 KWK GMB-800	40542891 ZPOK GMB-800	40542862 KWP GMB-800	40542821 SWY GMB-800	40542921 RK GMB-800
40542830 KW GMB-250	40542870 ZPO GMB-250	40542930 Dämpfer GMB-250	40542892 ZPP GMB-250	40542910 R GMB-250	40542945 Rahmen GMB-450
40542831 KW GMB-280	40542871 ZPO GMB-280	40542931 Dämpfer GMB-280	40542893 ZPP GMB-280	40542911 R GMB-280	40542946 Rahmen GMB-500
40542832 KW GMB-315	40542872 ZPO GMB-315	40542932 Dämpfer GMB-315	40542894 ZPP GMB-315	40542912 R GMB-315	40542947 Rahmen GMB-560
40542833 KW GMB-355	40542873 ZPO GMB-355	40542933 Dämpfer GMB-355	40542895 ZPP GMB-355	40542913 R GMB-355	40542948 Rahmen GMB-630
40542834 KW GMB-400	40542874 ZPO GMB-400	40542934 Dämpfer GMB-400	40542896 ZPP GMB-400	40542914 R GMB-400	40542949 Rahmen GMB-710
40542835 KW GMB-450	40542875 ZPO GMB-450	40542935 Dämpfer GMB-450	40542897 ZPP GMB-450	40542915 R GMB-450	40542950 Rahmen GMB-800
40542836 KW GMB-500	40542876 ZPO GMB-500	40542936 Dämpfer GMB-500	40542898 ZPP GMB-500	40542916 R GMB-500	
40542837 KW GMB-560	40542877 ZPO GMB-560	40542937 Dämpfer GMB-560	40542899 ZPP GMB-560	40542917 R GMB-560	26040960 AVM-20
40542838 KW GMB-630	40542878 ZPO GMB-630	40542938 Dämpfer GMB-630	40542900 ZPP GMB-630	40542918 R GMB-630	26040965 AVM-35
40542839 KW GMB-710	40542879 ZPO GMB-710	40542939 Dämpfer GMB-710	40542901 ZPP GMB-710	40542919 R GMB-710	26040970 AVM-140
40542840 KW GMB-800	40542880 ZPO GMB-800	40542940 Dämpfer GMB-800	40542902 ZPP GMB-800	40542920 R GMB-800	

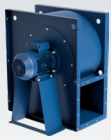

ELEKTRISCHES ZUBEHÖR

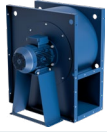

Typ	Wandler L	Umschalter
GMB-2-25A-018T	L 0,4 kW	R-S 3-F + SP, 10A
GMB-2-25B-025T	L 0,4 kW	R-S 3-F + SP, 10A
GMB-2-25C-037T	L 0,4 kW	R-S 3-F + SP, 10A
GMB-2-28A-037T	L 0,4 kW	R-S 3-F + SP, 10A
GMB-2-28B-055T	L 0,75 kW	R-S 3-F + SP, 10A
GMB-2-28C-055T	L 0,75 kW	R-S 3-F + SP, 10A
GMB-2-31A-055T	L 0,75 kW	R-S 3-F + SP, 10A
GMB-2-31B-075T	L 0,75 kW	R-S 3-F + SP, 10A
GMB-2-31C-110T	L 1,5 kW	R-S 3-F + SP, 10A
GMB-2-35A-110T	L 1,5 kW	R-S 3-F + SP, 10A
GMB-2-35B-150T	L 1,5 kW	R-S 3-F + SP, 10A
GMB-2-35C-220T	L 2,2 kW	R-S 3-F + SP, 10A
GMB-2-40A-150T	L 1,5 kW	R-S 3-F + SP, 10A
GMB-2-40B-220T	L 2,2 kW	R-S 3-F + SP, 10A
GMB-2-40C-300T	L 4,0 kW	R-S 3-F + SP, 10A
GMB-2-45A-300T	L 4,0 kW	R-S 3-F + SP, 10A
GMB-2-45B-400T	L 4,0 kW	R-S 3-F + SP, 10A
GMB-2-45C-550T	L 5,5 kW	R-S 3-F + SP, 16A
GMB-2-50A-550T	L 5,5 kW	R-S 3-F + SP, 16A
GMB-2-50B-750T	L 7,5 kW	R-S 3-F + SP, 16A
GMB-2-50C-1100T	L 11,0 kW	R-S 3-F + SP, 25A
GMB-2-56A-1100T	L 11,0 kW	R-S 3-F + SP, 25A
GMB-2-56B-1500T	L 15,0 kW	R-S 3-F + SP, 40A
GMB-2-56C-1850T	L 18,5 kW	R-S 3-F + SP, 40A
GMB-2-63A-1850T	L 18,5 kW	R-S 3-F + SP, 40A
GMB-2-63B-2200T	L 22,0 kW	R-S 3-F + SP, 40A
GMB-2-63C-3000T	L 30,0 kW	R-S 3-F + SP, 63A

Typ	Wandler L	Umschalter
GMB-4-35A-012T	L 0,4 kW	R-S 3-F + SP, 10A
GMB-4-35B-018T	L 0,4 kW	R-S 3-F + SP, 10A
GMB-4-35C-025T	L 0,4 kW	R-S 3-F + SP, 10A
GMB-4-40A-018T	L 0,4 kW	R-S 3-F + SP, 10A
GMB-4-40B-025T	L 0,4 kW	R-S 3-F + SP, 10A
GMB-4-40C-037T	L 0,4 kW	R-S 3-F + SP, 10A
GMB-4-45A-037T	L 0,4 kW	R-S 3-F + SP, 10A
GMB-4-45B-055T	L 0,75 kW	R-S 3-F + SP, 10A
GMB-4-45C-075T	L 0,75 kW	R-S 3-F + SP, 10A
GMB-4-50A-075T	L 0,75 kW	R-S 3-F + SP, 10A
GMB-4-50B-110T	L 1,5 kW	R-S 3-F + SP, 10A
GMB-4-50C-150T	L 1,5 kW	R-S 3-F + SP, 10A
GMB-4-56A-110T	L 1,5 kW	R-S 3-F + SP, 10A
GMB-4-56B-150T	L 1,5 kW	R-S 3-F + SP, 10A
GMB-4-56C-220T	L 2,2 kW	R-S 3-F + SP, 10A
GMB-4-63A-220T	L 2,2 kW	R-S 3-F + SP, 10A
GMB-4-63B-300T	L 4,0 kW	R-S 3-F + SP, 10A
GMB-4-63C-400T	L 4,0 kW	R-S 3-F + SP, 10A
GMB-4-71A-400T	L 4,0 kW	R-S 3-F + SP, 10A
GMB-4-71B-550T	L 5,5 kW	R-S 3-F + SP, 16A
GMB-4-71C-750T	L 7,5 kW	R-S 3-F + SP, 16A
GMB-4-80A-750T	L 7,5 kW	R-S 3-F + SP, 16A
GMB-4-80B-1100T	L 11,0 kW	R-S 3-F + SP, 25A
GMB-4-80C-1500T	L 15,0 kW	R-S 3-F + SP, 40A

Typ	Wandler L	Umschalter
GMB-6-71A-110T	L 1,5 kW	R-S 3-F + SP, 10A
GMB-6-71B-150T	L 1,5 kW	R-S 3-F + SP, 10A
GMB-6-71C-220T	L 2,2 kW	R-S 3-F + SP, 10A
GMB-6-80A-220T	L 2,2 kW	R-S 3-F + SP, 10A
GMB-6-80B-300T	L 4,0 kW	R-S 3-F + SP, 10A
GMB-6-80C-400T	L 4,0 kW	R-S 3-F + SP, 10A

Artikelnummer

40016302	Wandler L 0,4kW	91040908-01	R-S 3-F + SP, 10A
40016312	Wandler L 0,75kW	91040908	R-S 3-F + SP, 16A
40016322	Wandler L 1,5kW	91040910	R-S 3-F + SP, 25A
40016332	Wandler L 2,2kW	91040924	R-S 3-F + SP, 40A
40016352	Wandler L 4,0kW	91040911-03	R-S 3-F + SP, 63A
40016362	Wandler L 5,5kW		
40016372	Wandler L 7,5kW		
40016383	Wandler L 11,0kW		
40016393	Wandler L 15,0kW		
40016412	Wandler L 18,5kW		
40016422	Wandler L 22,0kW		