

Anwendung

HB2C-Ventilatoren sind für den Transport sauberer Luft ausgelegt. Sie haben viele Anwendungen in der Industrie, wo eine kleine Menge Hochdruckluft in technologischen Prozessen zugeführt werden muss, einschließlich:

- Luftversorgung von Gasbrenneranlagen
- Filtersysteme,
- pneumatischer Transport,
- Trocknungssysteme,
- Kühlsysteme.

Konstruktion

- Hochdruck- und Höchstdruck-Radialventilator mit Direktantrieb,
- Laufrad aus Stahlblech mit rückwärts geneigten Schaufeln,
- Gehäuse aus Stahlblech
- Lüfter blau lackiert RAL 5010 (Korrosivitätskategorie C3),
- maximale Temperatur des Fördermediums 80°C,
- Motorumgebungstemperatur von -30°C bis 60°C (je nach Modell - siehe Tabelle der technischen Daten),
- Lüfter sind Standard in der LG270-Figur.

Elektrischer Motor

- Asynchron, dreiphasig, 230 / 400V 50Hz oder 400 / 690V 50Hz, Effizienzklasse IE3
- Schutzart IP55,
- Isolationsklasse F,
- An Frequenzregelung angepasster Motor.

Sonderausführungen

- Jede LG / RD Figur,
- Lackierung in einer anderen Farbe als der Standardfarbe und in einer höheren Korrosivitätskategorie,
- Aus verzinktem Stahlblech, Edelstahl 1.4301, säurebeständig 1.4404,
- Motor für abweichende Spannung und Netzfrequenz, mit abweichender IP-Schutzart, ausgestattet mit Sensoren oder zusätzlicher Kühlung, mit der Effizienzklasse IE4,
- Abdichtung zwischen Gehäuse und Motor,
- HT-Version - maximale Temperatur des gepumpten Mediums höher als die Standardtemperatur,
- Motorumgebungstemperatur unter -30°C und über 40°C,
- Riemenantrieb, Kupplung,
- Explosionsgeschützte ATEX-Version.

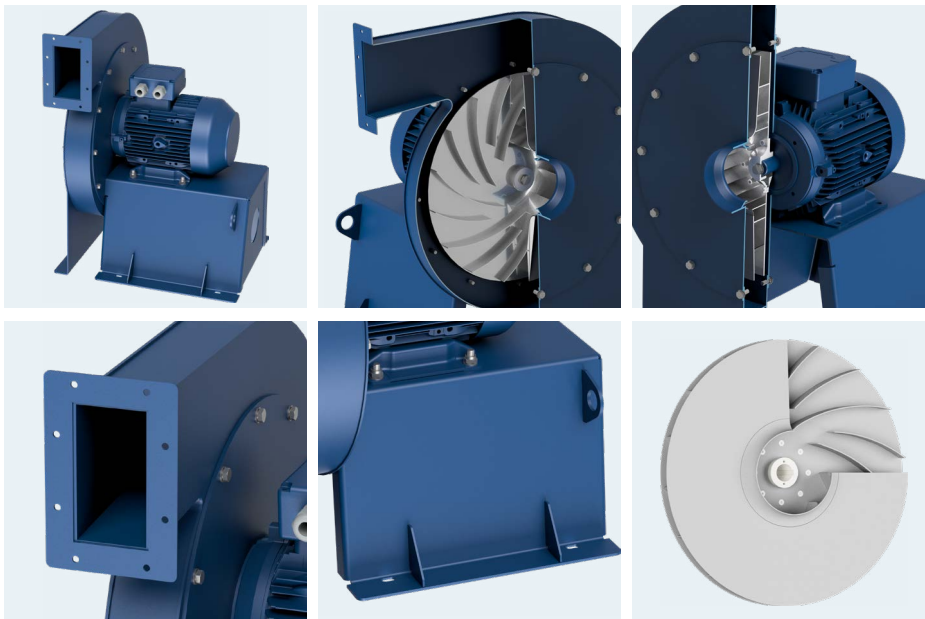

VERWANDTE PRODUKTE

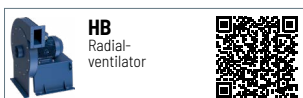



NENNDATEN

Typ	Volumenstrom max	Druck max	Motor Drehzahl	Nennspannung	Nennstrom**	Motorleistung	Schalldruckpegel Fall*	Temperaturbetrieb min / max	Temperaturumgebungs min / max	Gewicht	Artikelnummer
DREIPHASIGE, 3000RPM											
HB2C-2-40-075T	850 m ³ /h	2 920 Pa	2 890 rpm	3~400 V	1,7 A	0,75 kW	67 dB(A)	-30 / 80 °C	-30 / 40 °C	52,0 kg	436054020
HB2C-2-40-110T	1 340 m ³ /h	2 920 Pa	2 890 rpm	3~400 V	2,5 A	1,1 kW	65 dB(A)	-30 / 80 °C	-30 / 40 °C	53,0 kg	436054021
HB2C-2-40-150T	1 600 m ³ /h	2 920 Pa	2 880 rpm	3~400 V	3,0 A	1,5 kW	62 dB(A)	-30 / 80 °C	-30 / 40 °C	58,0 kg	436054022
HB2C-2-45-110T	800 m ³ /h	3 700 Pa	2 890 rpm	3~400 V	2,5 A	1,1 kW	70 dB(A)	-30 / 80 °C	-30 / 40 °C	60,0 kg	436054520
HB2C-2-45-150T	1 250 m ³ /h	3 700 Pa	2 880 rpm	3~400 V	3,0 A	1,5 kW	69 dB(A)	-30 / 80 °C	-30 / 40 °C	65,0 kg	436054521
HB2C-2-45-220T	2 200 m ³ /h	3 700 Pa	2 910 rpm	3~400 V	4,3 A	2,2 kW	66 dB(A)	-30 / 80 °C	-30 / 40 °C	66,0 kg	436054522
HB2C-2-50-220T	1 430 m ³ /h	4 570 Pa	2 910 rpm	3~400 V	4,3 A	2,2 kW	74 dB(A)	-30 / 80 °C	-30 / 40 °C	75,0 kg	436055020
HB2C-2-50-300T	2 200 m ³ /h	4 570 Pa	2 915 rpm	3~400 V	5,3 A	3,0 kW	73 dB(A)	-30 / 80 °C	-30 / 40 °C	81,0 kg	436055021
HB2C-2-50-400T	3 140 m ³ /h	4 570 Pa	2 895 rpm	3~400 V	7,3 A	4,0 kW	68 dB(A)	-30 / 80 °C	-30 / 40 °C	92,0 kg	436055022
HB2C-2-56-400T	2 130 m ³ /h	5 730 Pa	2 895 rpm	3~400 V	7,3 A	4,0 kW	77 dB(A)	-30 / 80 °C	-30 / 40 °C	104,0 kg	436055620
HB2C-2-56-550T	3 280 m ³ /h	5 730 Pa	2 940 rpm	3~400 V	10 A	5,5 kW	75 dB(A)	-30 / 80 °C	-30 / 40 °C	123,0 kg	436055621
HB2C-2-56-750T	4 600 m ³ /h	5 730 Pa	2 930 rpm	3~400 V	13,3 A	7,5 kW	72 dB(A)	-30 / 80 °C	-30 / 40 °C	132,0 kg	436055622
HB2C-2-63-550T	2 150 m ³ /h	7 250 Pa	2 940 rpm	3~400 V	10 A	5,5 kW	81 dB(A)	-30 / 80 °C	-30 / 40 °C	144,0 kg	436056320
HB2C-2-63-750T	3 240 m ³ /h	7 250 Pa	2 930 rpm	3~400 V	13,3 A	7,5 kW	81 dB(A)	-30 / 80 °C	-30 / 40 °C	153,0 kg	436056321
HB2C-2-63-1100T	5 450 m ³ /h	7 250 Pa	2 925 rpm	3~400 V	19,3 A	11 kW	78 dB(A)	-30 / 80 °C	-30 / 40 °C	212,0 kg	436056322
HB2C-2-63-1500T	6 220 m ³ /h	7 250 Pa	2 940 rpm	3~400 V	26 A	15 kW	75 dB(A)	-30 / 80 °C	-30 / 40 °C	221,0 kg	436056323
HB2C-2-71-1100T	3 400 m ³ /h	9 200 Pa	2 925 rpm	3~400 V	19,3 A	11 kW	84 dB(A)	-30 / 80 °C	-30 / 40 °C	233,0 kg	436057120
HB2C-2-71-1500T	5 050 m ³ /h	9 200 Pa	2 940 rpm	3~400 V	26 A	15 kW	84 dB(A)	-30 / 80 °C	-30 / 40 °C	244,0 kg	436057121
HB2C-2-71-1850T	7 150 m ³ /h	9 200 Pa	2 940 rpm	3~400 V	32,1 A	18,5 kW	82 dB(A)	-30 / 80 °C	-30 / 40 °C	251,0 kg	436057122
HB2C-2-71-2200T	9 000 m ³ /h	9 200 Pa	2 950 rpm	3~400 V	38,1 A	22 kW	79 dB(A)	-30 / 80 °C	-30 / 40 °C	302,0 kg	436057123
HB2C-2-80-2200T	5 300 m ³ /h	11 700 Pa	2 950 rpm	3~400 V	38,1 A	22 kW	88 dB(A)	-30 / 80 °C	-30 / 40 °C	327,0 kg	436058020
HB2C-2-80-3000T	8 400 m ³ /h	11 700 Pa	2 965 rpm	3~400 V	53 A	30 kW	87 dB(A)	-30 / 80 °C	-30 / 40 °C	395,0 kg	436058021
HB2C-2-80-3700T	11 000 m ³ /h	11 700 Pa	2 955 rpm	3~400 V	65 A	37 kW	84 dB(A)	-30 / 80 °C	-30 / 40 °C	410,0 kg	436058022
HB2C-2-80-4500T	12 800 m ³ /h	11 700 Pa	2 960 rpm	3~400 V	77 A	45 kW	82 dB(A)	-30 / 80 °C	-30 / 40 °C	525,0 kg	436058023
HB2C-2-90-3700T	7 000 m ³ /h	14 800 Pa	2 955 rpm	3~400 V	65 A	37 kW	92 dB(A)	-30 / 80 °C	-30 / 40 °C	454,0 kg	436059020
HB2C-2-90-4500T	9 200 m ³ /h	14 800 Pa	2 960 rpm	3~400 V	77 A	45 kW	92 dB(A)	-30 / 80 °C	-30 / 40 °C	576,0 kg	436059021
HB2C-2-90-5500T	12 000 m ³ /h	14 800 Pa	2 970 rpm	3~400 V	92 A	55 kW	90 dB(A)	-30 / 80 °C	-30 / 40 °C	611,0 kg	436059022
HB2C-2-90-7500T	18 290 m ³ /h	14 800 Pa	2 960 rpm	3~400 V	127 A	75 kW	87 dB(A)	-30 / 80 °C	-30 / 40 °C	761,0 kg	436059023
HB2C-2-100-7500T	11 500 m ³ /h	18 200 Pa	2 960 rpm	3~400 V	127 A	75 kW	95 dB(A)	-30 / 80 °C	-30 / 40 °C	789,0 kg	436051020
HB2C-2-100-9000T	15 500 m ³ /h	18 200 Pa	2 980 rpm	3~400 V	150 A	90 kW	95 dB(A)	-30 / 80 °C	-30 / 40 °C	879,0 kg	436051021
HB2C-2-100-11000T	22 000 m ³ /h	18 200 Pa	2 980 rpm	3~400 V	183 A	110 kW	92 dB(A)	-30 / 80 °C	-30 / 40 °C	1 026,0 kg	436051022
HB2C-2-100-13200T	25 000 m ³ /h	18 200 Pa	2 975 rpm	3~400 V	222 A	132 kW	91 dB(A)	-30 / 80 °C	-30 / 40 °C	1 196,0 kg	436051023

* Messung in 1,5 m Entfernung vom Auslass, für $Q = 2/3 \cdot Q_{max}$
 ** Der Nennstrom ist abhängig von eingesetztem Motorfabrikat.



NENNDATEN

Typ	Volumenstrom max	Druck max	Motor Drehzahl	Nennspannung	Nennstrom**	Motorleistung	Schalldruckpegel Fall*	Temperaturbetrieb min / max	Temperaturumgebungs min / max	Gewicht	Artikelnummer
DREIPHASIGE, 1500RPM											
HB2C-4-40-012T	580 m ³ /h	700 Pa	1 380 rpm	3~400 V	0,45 A	0,12 kW	51 dB(A)	-30 / 80 °C	-30 / 40 °C	45,0 kg	436054040
HB2C-4-40-018T	780 m ³ /h	700 Pa	1 380 rpm	3~400 V	0,65 A	0,18 kW	47 dB(A)	-30 / 80 °C	-30 / 40 °C	45,0 kg	436054041
HB2C-4-45-018T	620 m ³ /h	890 Pa	1 380 rpm	3~400 V	0,65 A	0,18 kW	55 dB(A)	-30 / 80 °C	-15 / 40 °C	53,0 kg	436054540
HB2C-4-45-025T	1 070 m ³ /h	890 Pa	1 380 rpm	3~400 V	0,85 A	0,25 kW	52 dB(A)	-30 / 80 °C	-15 / 40 °C	54,0 kg	436054541
HB2C-4-50-025T	640 m ³ /h	1 100 Pa	1 380 rpm	3~400 V	0,85 A	0,25 kW	59 dB(A)	-30 / 80 °C	-15 / 40 °C	61,0 kg	436055040
HB2C-4-50-037T	1 100 m ³ /h	1 100 Pa	1 370 rpm	3~400 V	1,15 A	0,37 kW	57 dB(A)	-30 / 80 °C	-30 / 40 °C	62,0 kg	436055041
HB2C-4-50-055T	1 540 m ³ /h	1 100 Pa	1 400 rpm	3~400 V	1,70 A	0,55 kW	54 dB(A)	-30 / 80 °C	-30 / 40 °C	63,0 kg	436055042
HB2C-4-56-037T	900 m ³ /h	1 380 Pa	1 370 rpm	3~400 V	1,2 A	0,37 kW	62 dB(A)	-30 / 80 °C	-30 / 40 °C	74,0 kg	436055640
HB2C-4-56-055T	1 230 m ³ /h	1 380 Pa	1 400 rpm	3~400 V	1,70 A	0,55 kW	61 dB(A)	-30 / 80 °C	-15 / 40 °C	75,0 kg	436055641
HB2C-4-56-075T	2 260 m ³ /h	1 380 Pa	1 430 rpm	3~400 V	2,1 A	0,75 kW	57 dB(A)	-30 / 80 °C	-15 / 40 °C	79,0 kg	436055642
HB2C-4-63-075T	1 200 m ³ /h	1 750 Pa	1 430 rpm	3~400 V	2,1 A	0,75 kW	65 dB(A)	-30 / 80 °C	-15 / 40 °C	100,0 kg	436056340
HB2C-4-63-110T	2 050 m ³ /h	1 750 Pa	1 430 rpm	3~400 V	2,5 A	1,1 kW	64 dB(A)	-30 / 80 °C	-30 / 40 °C	107,0 kg	436056341
HB2C-4-63-150T	3 070 m ³ /h	1 750 Pa	1 440 rpm	3~400 V	3,6 A	1,5 kW	60 dB(A)	-30 / 80 °C	-30 / 40 °C	117,0 kg	436056342
HB2C-4-71-150T	1 900 m ³ /h	2 220 Pa	1 440 rpm	3~400 V	3,6 A	1,5 kW	69 dB(A)	-30 / 80 °C	-30 / 40 °C	138,0 kg	436057140
HB2C-4-71-220T	3 500 m ³ /h	2 220 Pa	1 465 rpm	3~400 V	4,6 A	2,2 kW	67 dB(A)	-30 / 80 °C	-30 / 40 °C	138,0 kg	436057141
HB2C-4-71-300T	4 400 m ³ /h	2 220 Pa	1 460 rpm	3~400 V	6,7 A	3,0 kW	64 dB(A)	-30 / 80 °C	-15 / 40 °C	141,0 kg	436057142
HB2C-4-80-300T	3 050 m ³ /h	2 820 Pa	1 460 rpm	3~400 V	6,7 A	3,0 kW	72 dB(A)	-30 / 80 °C	-15 / 40 °C	165,0 kg	436058040
HB2C-4-80-400T	4 800 m ³ /h	2 820 Pa	1 460 rpm	3~400 V	8,1 A	4,0 kW	71 dB(A)	-30 / 80 °C	-30 / 60 °C	176,0 kg	436058041
HB2C-4-80-550T	6 300 m ³ /h	2 820 Pa	1 460 rpm	3~400 V	10,9 A	5,5 kW	67 dB(A)	-30 / 80 °C	-30 / 40 °C	197,0 kg	436058042
HB2C-4-90-400T	3 050 m ³ /h	3 570 Pa	1 460 rpm	3~400 V	8,1 A	4,0 kW	77 dB(A)	-30 / 80 °C	-30 / 40 °C	225,0 kg	436059040
HB2C-4-90-550T	4 800 m ³ /h	3 570 Pa	1 460 rpm	3~400 V	10,9 A	5,5 kW	76 dB(A)	-30 / 80 °C	-30 / 40 °C	247,0 kg	436059041
HB2C-4-90-750T	7 450 m ³ /h	3 570 Pa	1 465 rpm	3~400 V	14,4 A	7,5 kW	74 dB(A)	-30 / 80 °C	-15 / 40 °C	251,0 kg	436059042
HB2C-4-90-1100T	8 990 m ³ /h	3 570 Pa	1 475 rpm	3~400 V	20,9 A	11 kW	71 dB(A)	-30 / 80 °C	-30 / 60 °C	320,0 kg	436059043
HB2C-4-100-750T	5 000 m ³ /h	4 400 Pa	1 465 rpm	3~400 V	14,4 A	7,5 kW	79 dB(A)	-30 / 80 °C	-30 / 60 °C	279,0 kg	436051040
HB2C-4-100-1100T	8 200 m ³ /h	4 400 Pa	1 475 rpm	3~400 V	20,9 A	11 kW	78 dB(A)	-30 / 80 °C	-30 / 60 °C	348,0 kg	436051041
HB2C-4-100-1500T	12 300 m ³ /h	4 400 Pa	1 475 rpm	3~400 V	28,1 A	15 kW	74 dB(A)	-30 / 80 °C	-30 / 40 °C	366,0 kg	436051042

* Messung in 1,5 m Entfernung vom Auslass, für Q = 2/3 * Qmax
 ** Der Nennstrom ist abhängig von eingesetztem Motorfabrikat.



LEISTUNGSMERKMALE DER VENTILATOREN - DREIPHASIGE 3000RPM 40-56

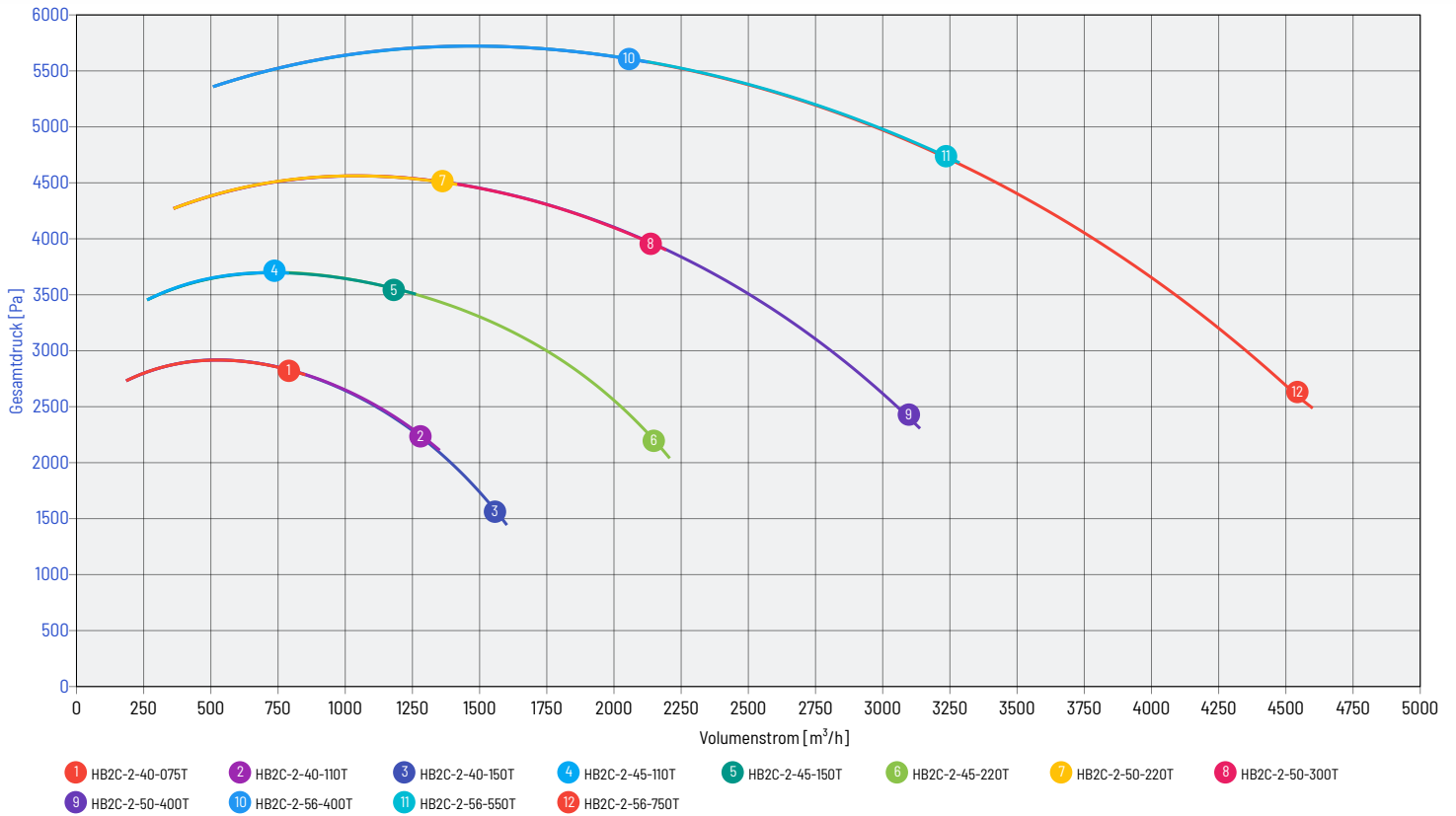

LEISTUNGSMERKMALE DER VENTILATOREN - DREIPHASIGE 3000RPM 63-100

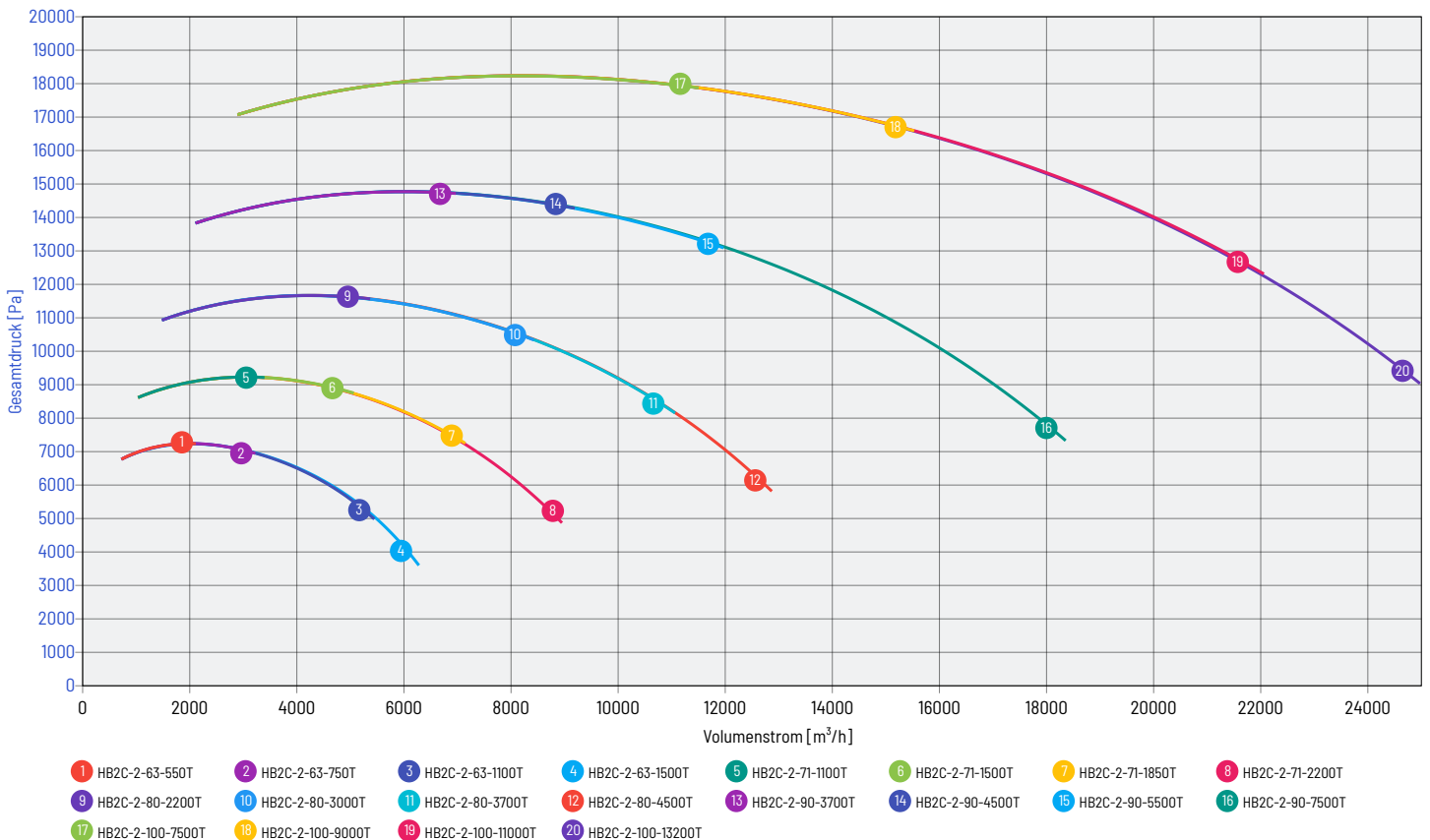



LEISTUNGSMERKMALE DER VENTILATOREN - DREIPHASIGE 1500RPM 40-56

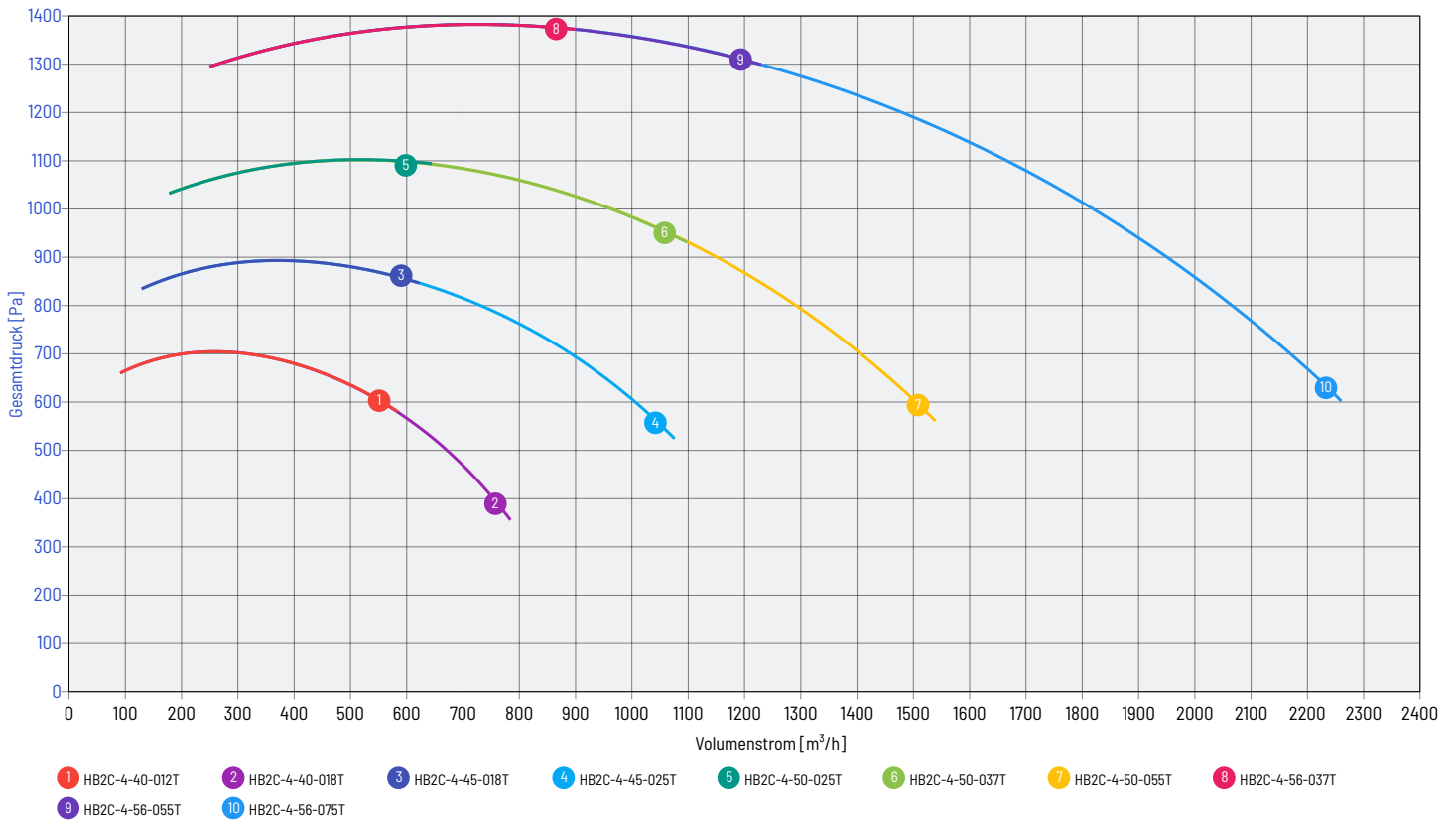

LEISTUNGSMERKMALE DER VENTILATOREN - DREIPHASIGE 1500RPM 63-100

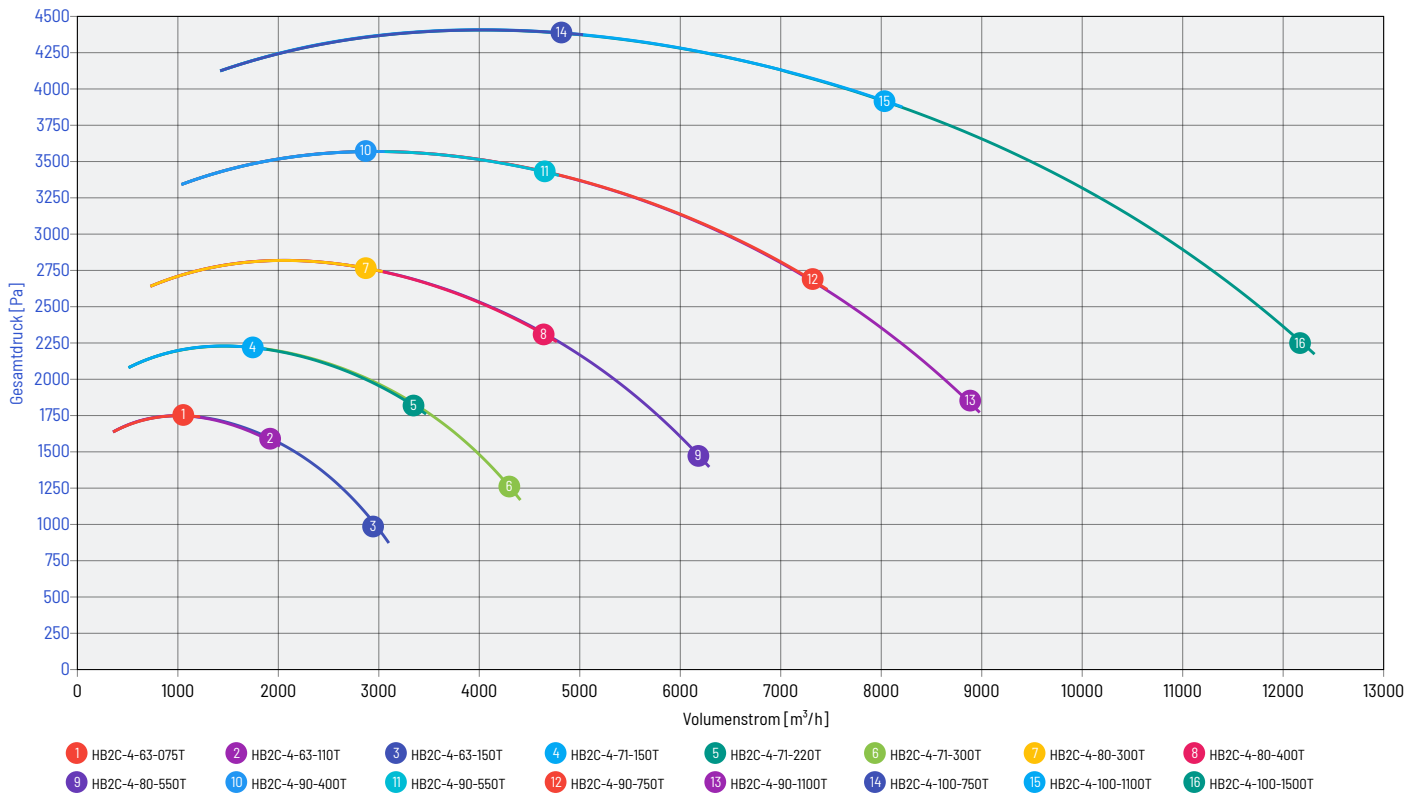



KENNLINIEN

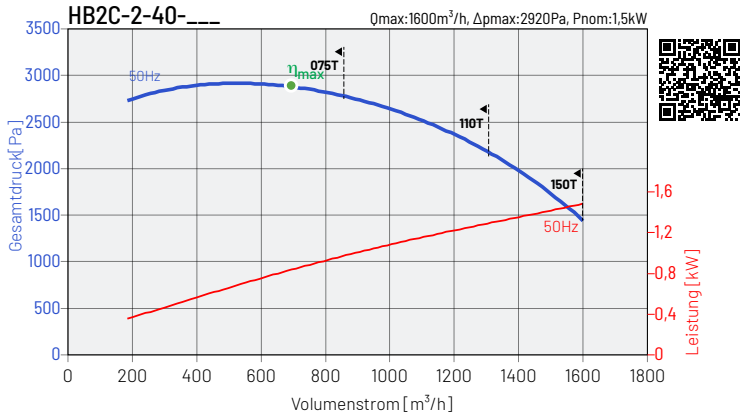

	MC	EC	SR	VSD	η %	N	kW	m ³ /h	Pa	rpm
075T	C	statisch	1	nein	59,3	70,6	0,84	671	2 672	2 890
110T	C	statisch	1	nein	60,0	71,4	0,83	671	2 672	2 890
150T	C	statisch	1	nein	60,3	71,7	0,82	669	2 654	2 880

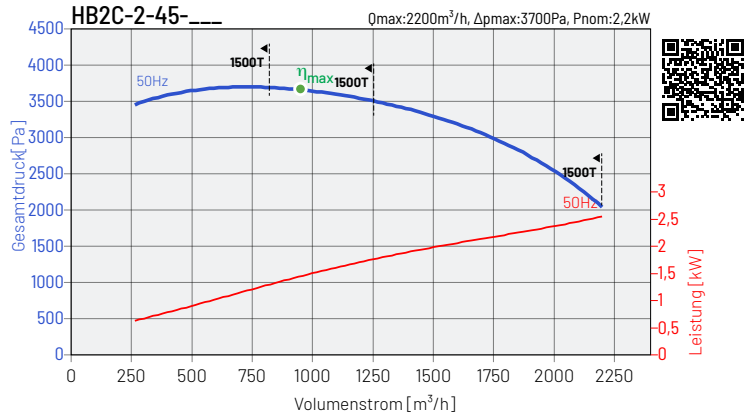

	MC	EC	SR	VSD	η %	N	kW	m ³ /h	Pa	rpm
110T	C	statisch	1	nein	58,1	66,8	1,50	946	3 309	2 890
150T	C	statisch	1	nein	58,4	67,1	1,48	943	3 286	2 880
220T	C	statisch	1	nein	61,4	70,3	1,45	953	3 355	2 910

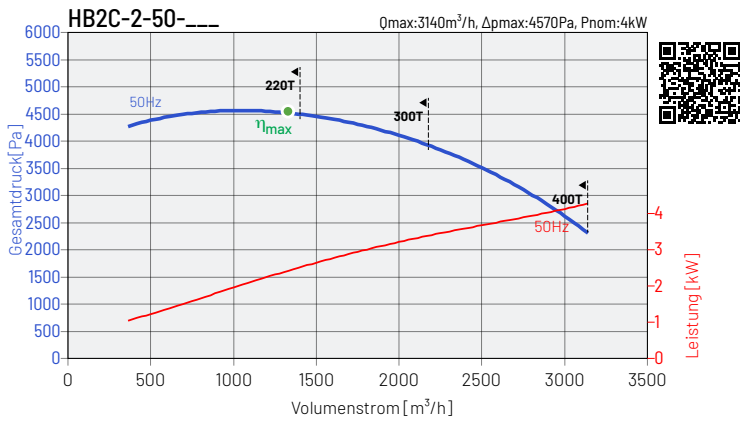

	MC	EC	SR	VSD	η %	N	kW	m ³ /h	Pa	rpm
220T	C	statisch	1	nein	62,4	68,8	2,45	1314	4 187	2 910
300T	C	statisch	1	nein	63,6	70,1	2,41	1316	4 201	2 915
400T	C	statisch	1	nein	63,0	69,6	2,39	1307	4 144	2 895

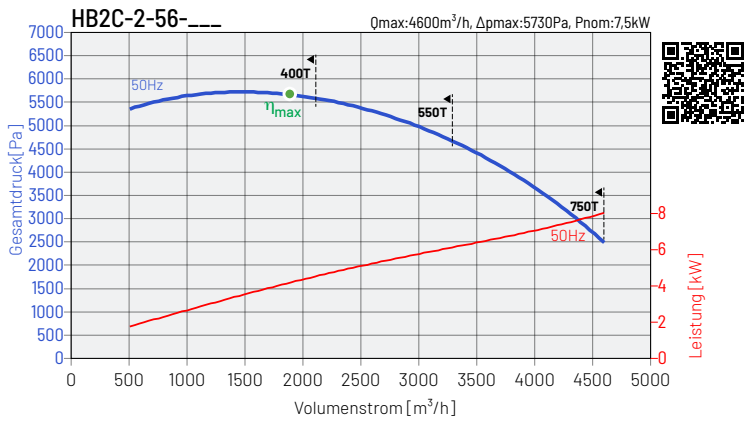

	MC	EC	SR	VSD	η %	N	kW	m ³ /h	Pa	rpm
400T	C	statisch	1	nein	62,0	65,9	4,21	1814	5 174	2 895
550T	C	statisch	1	nein	65,7	69,7	4,15	1842	5 336	2 940
750T	C	statisch	1	nein	65,7	69,8	4,11	1836	5 300	2 930

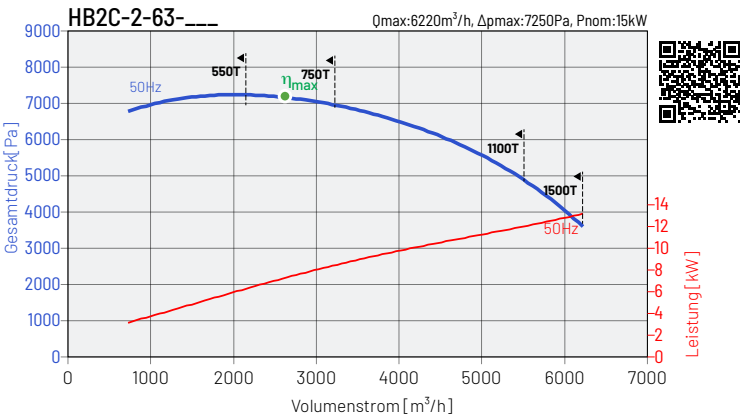

	MC	EC	SR	VSD	η %	N	kW	m ³ /h	Pa	rpm
550T	C	statisch	1	nein	63,8	65,1	7,49	2 614	6 576	2 940
750T	C	statisch	1	nein	64,4	65,8	7,34	2 605	6 531	2 930
1100T	C	statisch	1	nein	65,2	66,7	7,21	2 601	6 509	2 925
1500T	C	statisch	1	nein	65,7	67,2	7,27	2 614	6 576	2 940

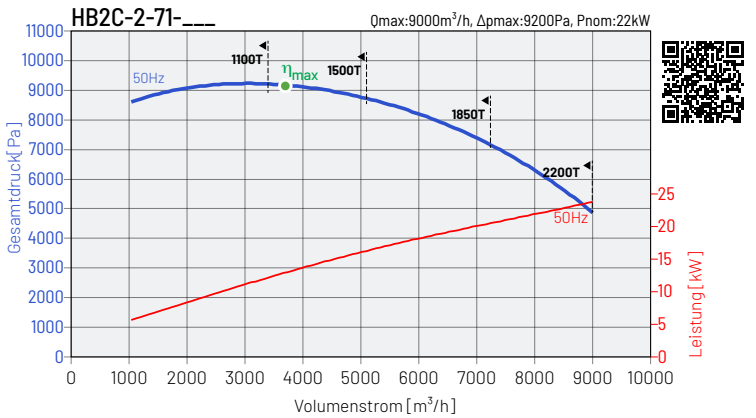

	MC	EC	SR	VSD	η %	N	kW	m ³ /h	Pa	rpm
1100T	C	statisch	1	nein	65,3	65,1	12,98	3 710	8 218	2 925
1500T	C	statisch	1	nein	65,8	65,6	13,08	3 729	8 303	2 940
1850T	C	statisch	1	nein	66,1	65,9	13,01	3 729	8 303	2 940
2200T	C	statisch	1	nein	66,4	66,1	13,10	3 742	8 360	2 950

Die Leistungsdaten der Ventilatoren sind für ein Medium mit einer Temperatur von 20°C. Schalldruckpegel dB(A), ermittelt in 1,5 m Entfernung



KENNLINIEN

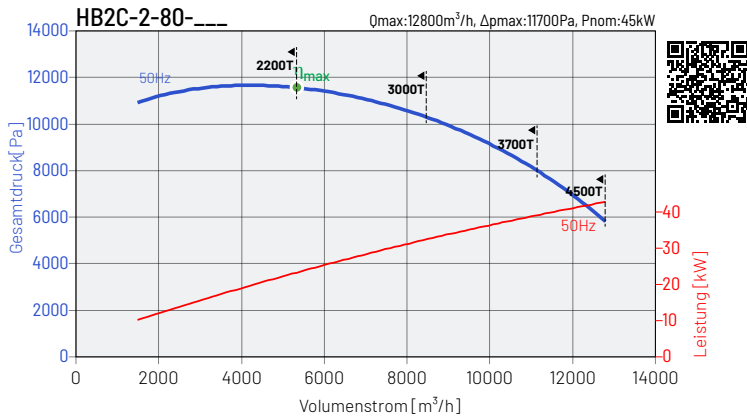

	MC	EC	SR	VSD	η %	N	kW	m^3/h	Pa	rpm
2200T	C	statisch	1	nein	66,1	65,2	23,62	5 335	10 529	2 950
3000T	C	statisch	1	nein	66,3	65,4	23,91	5 362	10 637	2 965
3700T	C	statisch	1	nein	66,8	66,0	23,46	5 344	10 565	2 955
4500T	C	statisch	1	nein	67,0	66,1	23,53	5 353	10 601	2 960

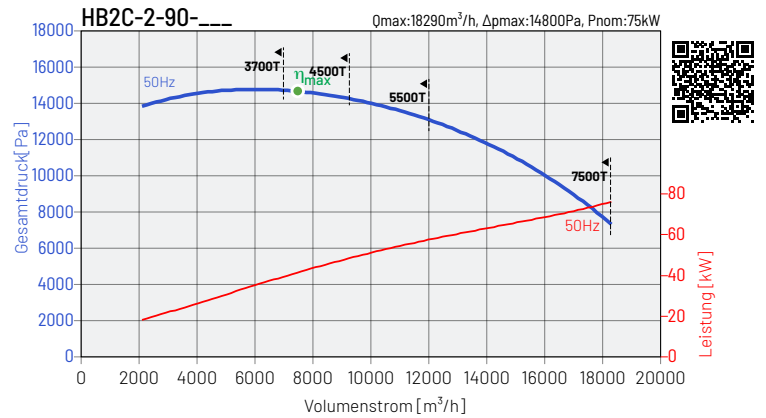

	MC	EC	SR	VSD	η %	N	kW	m^3/h	Pa	rpm
3700T	C	statisch	1	nein	67,1	65,5	41,93	7 608	13 386	2 955
4500T	C	statisch	1	nein	67,6	65,8	42,04	7 621	13 431	2 960
5500T	C	statisch	1	nein	67,7	66,0	42,41	7 647	13 522	2 970
7500T	C	statisch	1	nein	67,8	66,3	41,96	7 621	13 431	2 960

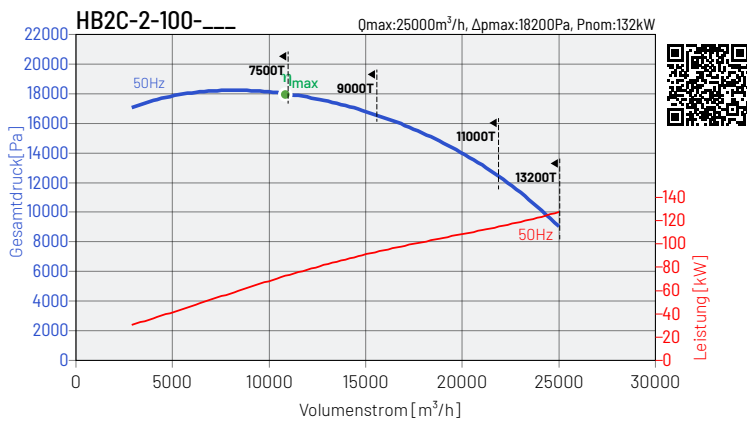

	MC	EC	SR	VSD	η %	N	kW	m^3/h	Pa	rpm
7500T	C	statisch	1	nein	70,1	68,1	67,63	10 401	16 411	2 980
9000T	C	statisch	1	nein	70,5	68,5	68,59	10 472	16 634	2 980
11000T	C	statisch	1	nein	70,8	68,7	68,38	10 472	16 634	2 980
13200T	C	statisch	1	nein	70,1	68,1	68,66	10 454	16 578	2 975

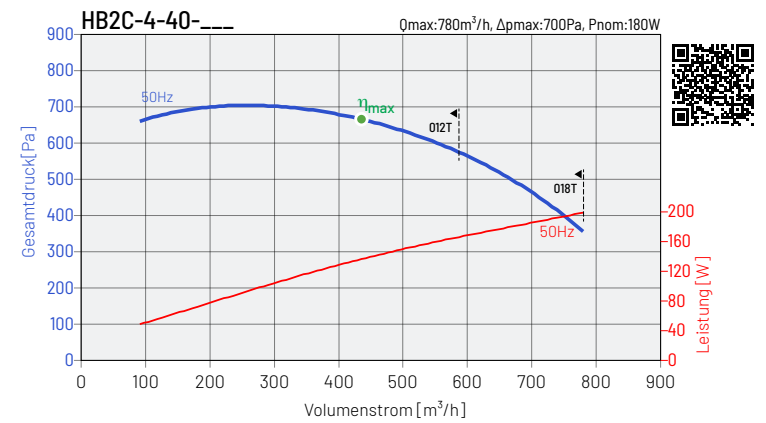

	MC	EC	SR	VSD	η %	N	kW	m^3/h	Pa	rpm
012T	C	statisch	1	nein	70,1	68,1	67,63	10 401	16 411	2 980
018T	C	statisch	1	nein	70,5	68,5	68,59	10 472	16 634	2 980

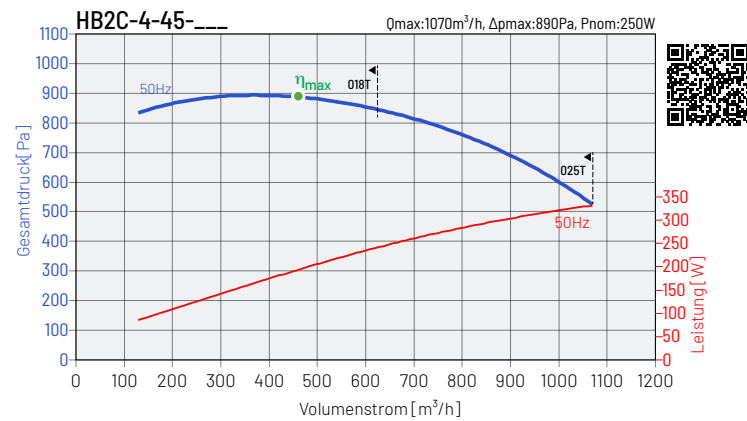

	MC	EC	SR	VSD	η %	N	kW	m^3/h	Pa	rpm
018T	C	statisch	1	nein	52,2	70,0	0,20	468	811	1 380
025T	C	statisch	1	nein	53,6	71,6	0,20	468	811	1 380

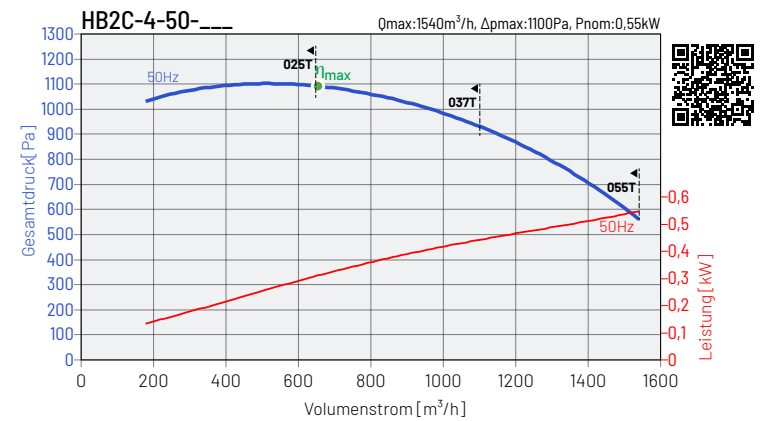

	MC	EC	SR	VSD	η %	N	kW	m^3/h	Pa	rpm
025T	C	statisch	1	nein	51,4	66,9	0,33	633	973	1 380
037T	C	statisch	1	nein	51,8	67,4	0,33	628	959	1 370
055T	C	statisch	1	nein	58,3	74,2	0,31	642	1 001	1 400

Die Leistungsdaten der Ventilatoren sind für ein Medium mit einer Temperatur von 20°C. Schalldruckpegel dB(A), ermittelt in 1,5 m Entfernung



KENNLINIEN

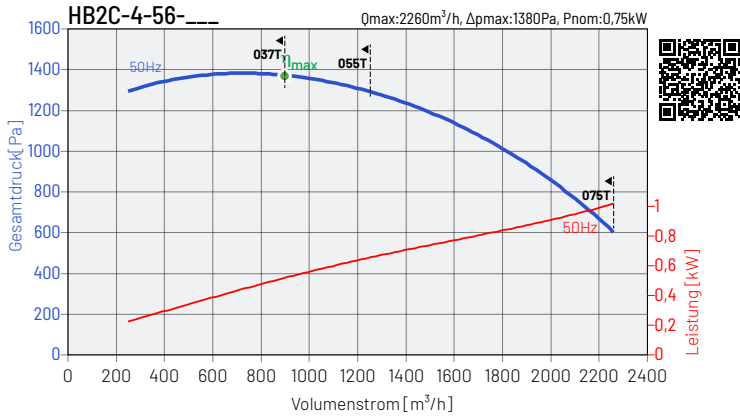

	MC	EC	SR	VSD	η %	N	kW	m ³ /h	Pa	rpm
037T	C	statisch	1	nein	52,3	65,6	0,54	864	1176	1370
055T	C	statisch	1	nein	56,5	69,8	0,53	883	1228	1400
075T	C	statisch	1	nein	61,3	74,8	0,52	902	1281	1430

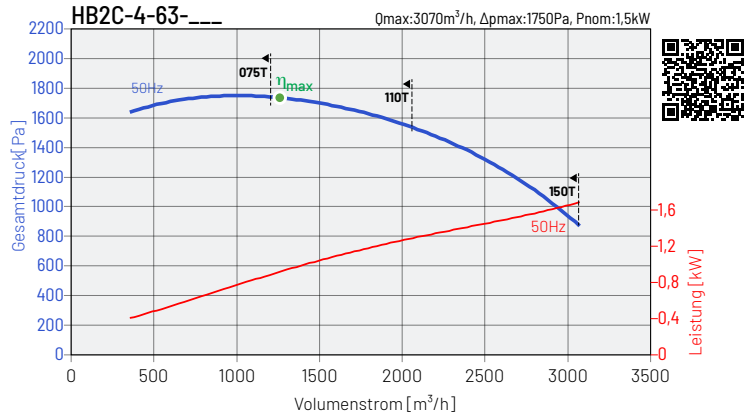

	MC	EC	SR	VSD	η %	N	kW	m ³ /h	Pa	rpm
075T	C	statisch	1	nein	59,0	69,8	0,94	1276	1567	1430
110T	C	statisch	1	nein	60,2	71,0	0,92	1276	1567	1430
150T	C	statisch	1	nein	61,0	71,8	0,93	1285	1589	1440

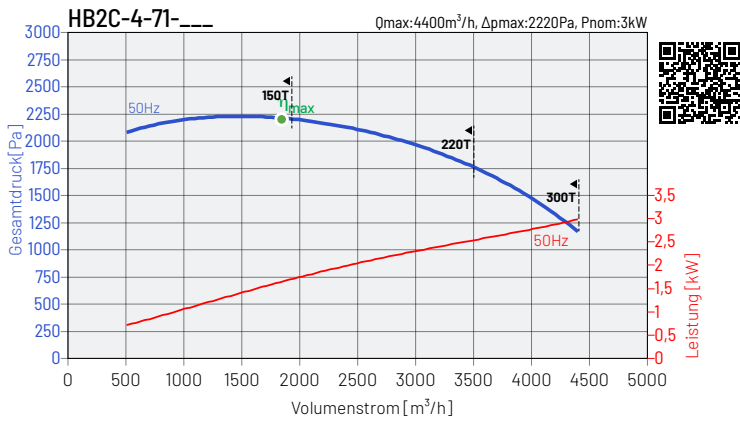

	MC	EC	SR	VSD	η %	N	kW	m ³ /h	Pa	rpm
150T	C	statisch	1	nein	61,0	69,3	1,62	1814	1963	1440
220T	C	statisch	1	nein	62,0	70,1	1,68	1845	2032	1465
300T	C	statisch	1	nein	62,8	71,0	1,64	1839	2018	1460

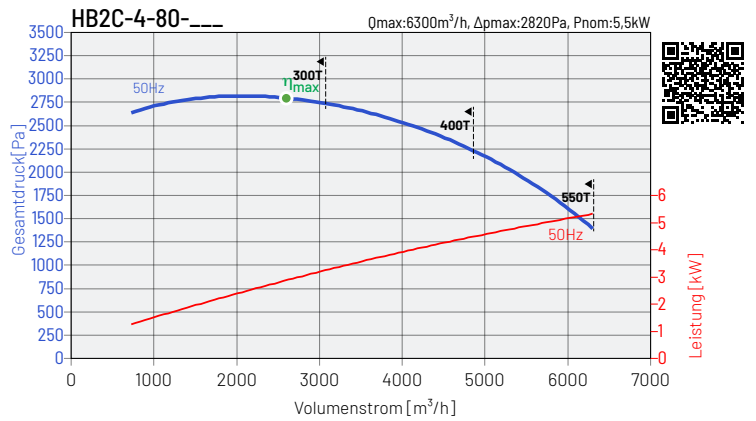

	MC	EC	SR	VSD	η %	N	kW	m ³ /h	Pa	rpm
300T	C	statisch	1	nein	62,7	68,2	2,99	2631	2561	1460
400T	C	statisch	1	nein	63,3	68,9	2,96	2631	2561	1460
550T	C	statisch	1	nein	64,1	69,7	2,92	2631	2561	1460

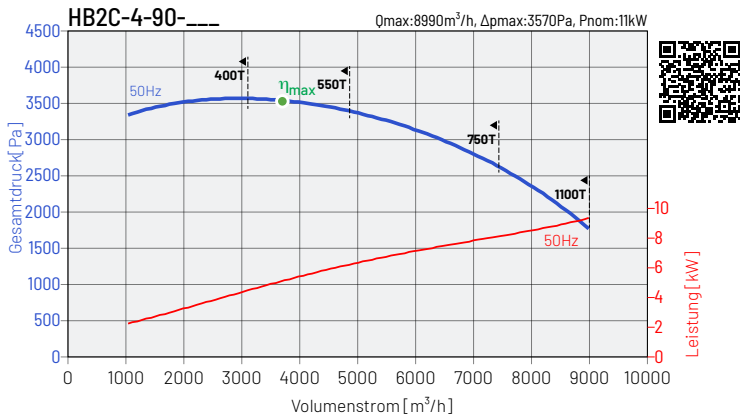

	MC	EC	SR	VSD	η %	N	kW	m ³ /h	Pa	rpm
400T	C	statisch	1	nein	63,4	66,4	5,16	3708	3179	1460
550T	C	statisch	1	nein	64,1	67,2	5,11	3708	3179	1460
750T	C	statisch	1	nein	64,7	67,8	5,11	3721	3201	1465
1100T	C	statisch	1	nein	65,4	68,4	5,16	3746	3245	1475

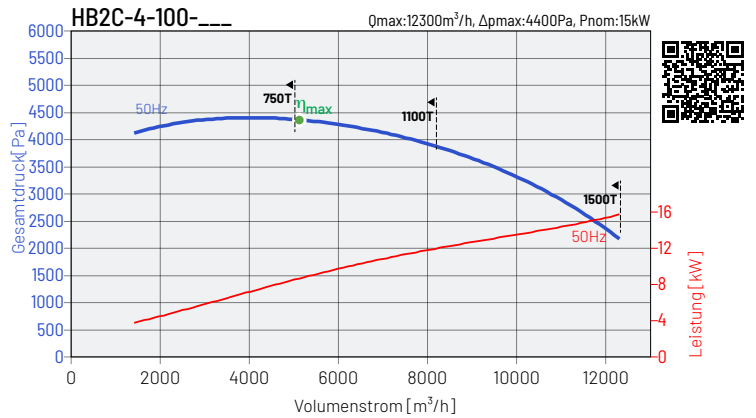

	MC	EC	SR	VSD	η %	N	kW	m ³ /h	Pa	rpm
750T	C	statisch	1	nein	64,1	64,7	8,74	5104	3951	1465
1100T	C	statisch	1	nein	64,7	65,2	8,84	5139	4005	1475
1500T	C	statisch	1	nein	65,9	66,5	8,68	5139	4005	1475

Die Leistungsdaten der Ventilatoren sind für ein Medium mit einer Temperatur von 20°C, Schalldruckpegel dB(A), ermittelt in 1,5 m Entfernung



ABMESSUNGEN

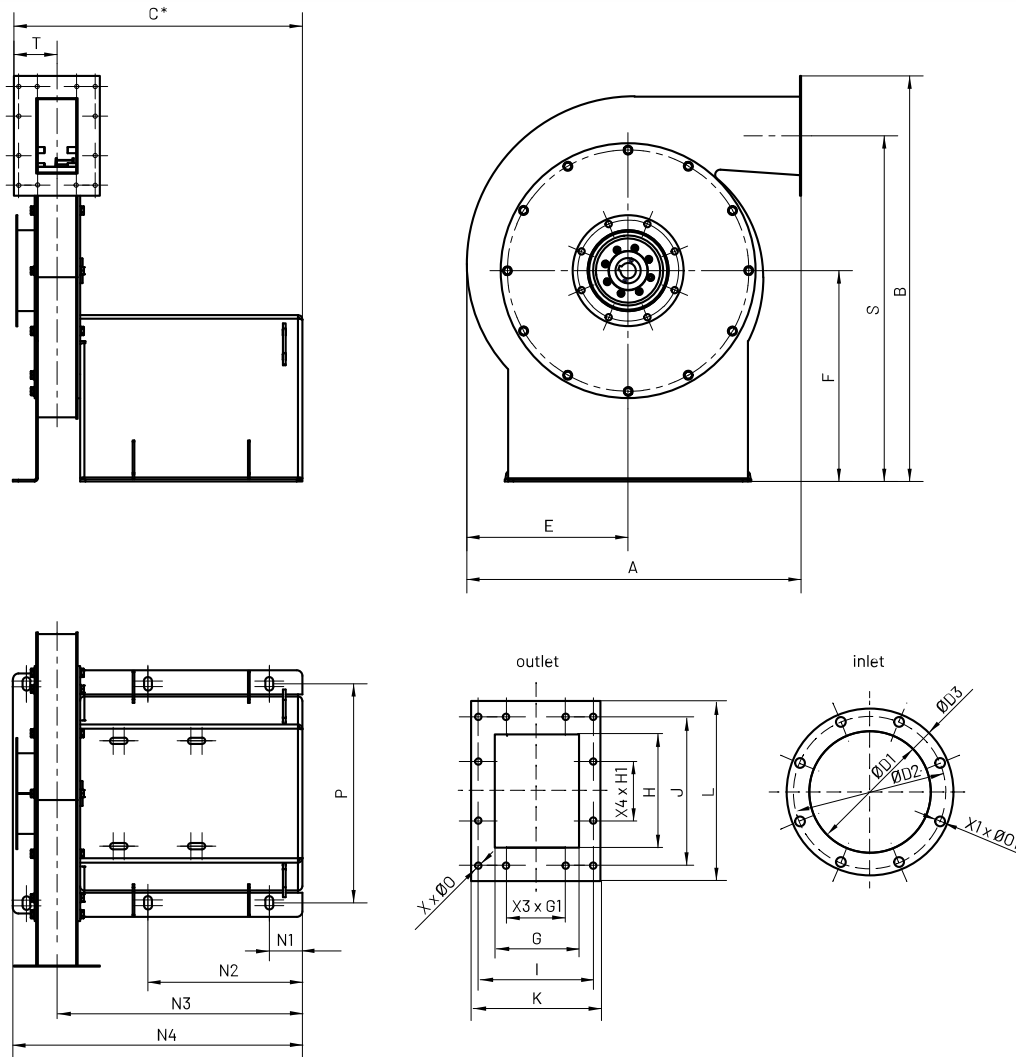

Typ	A	B	C*	ØD1	ØD2	ØD3	E	F	G	H	I	J
	mm	mm	mm	mm	mm	mm	mm	mm	mm	mm	mm	mm
HB2C-x-40x	603	731	520	140	182	200	291	380	69	132	138	178
HB2C-x-45x	678	770	528	160	200	220	326	380	77	148	138	178
HB2C-x-50x	754	814	532	180	219	240	362	390	85	165	138	198
HB2C-x-56x	837	840	544	200	241	260	405	380	108	185	138	218
HB2C-x-63x	937	964	544	225	265	290	455	450	108	208	138	238
HB2C-x-71x	1114	1076	551	250	292	310	512	500	118	235	138	262
HB2C-x-80x	1209	1261	700	280	332	360	577	600	137	264	178	318
HB2C-x-90x	1340	1478	838	315	366	390	648	750	155	297	198	318
HB2C-x-100x	1483	1518	867	355	405	430	720	750	172	330	218	393

* Maß für die längste Motorausführung (abhängig vom Motorhersteller)

Typ	K	L	N1	N2	N3	N4	P	S	X1 x Ø01	X3 x G1	X4 x H1	X x Ø0
	mm	mm	mm	mm	mm	mm	mm	mm	mm	mm	mm	mm
HB2C-x-40x	155	216	61	280	443	522	395	623	8x11,5	1x71	1x71	12x7
HB2C-x-45x	163	232	61	341	447	530	395	654	8x11,5	1x71	1x71	12x7
HB2C-x-50x	164	239	61	341	451	539	395	694	8x11,5	1x71	1x100	12x7
HB2C-x-56x	164	239	60	340	462	561	395	720	8x11,5	1x71	1x100	12x7
HB2C-x-63x	164	262	60	340	462	561	395	833	8x11,5	1x71	1x100	12x7
HB2C-x-71x	164	289	59	339	469	575	420	932	8x11,5	1x71	1x100	12x7
HB2C-x-80x	223	348	79	399	589	702	600	1087	8x11,5	1x71	1x125	12x10
HB2C-x-90x	221	361	106	526	681	834	740	1297	8x11,5	1x100	1x125	12x10
HB2C-x-100x	258	414	86	506	689	864	740	1309	8x11,5	1x100	2x125	14x10



FIGUR

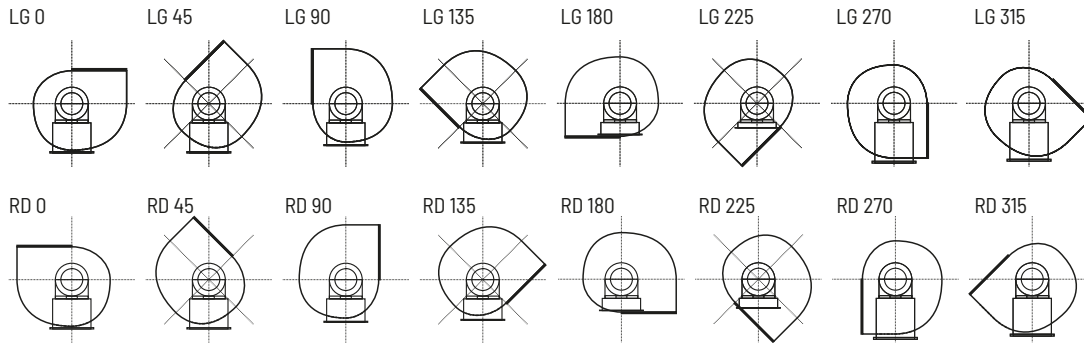

ELEKTRISCHES ZUBEHÖR



Typ	Wandler L	Umschalter	Typ	Wandler L	Umschalter	Typ	Wandler L	Umschalter
HB2C-2-40-075T	L 0,75 kW	R-S 3-F + SP, 10A	HB2C-2-80-2200T	L 22,0 kW	R-S 3-F + SP, 40A	HB2C-4-56-055T	L 0,75 kW	R-S 3-F + SP, 10A
HB2C-2-40-110T	L 1,5 kW	R-S 3-F + SP, 10A	HB2C-2-80-3000T	L 30,0 kW	R-S 3-F + SP, 63A	HB2C-4-56-075T	L 0,75 kW	R-S 3-F + SP, 10A
HB2C-2-40-150T	L 1,5 kW	R-S 3-F + SP, 10A	HB2C-2-80-3700T	auf Anfrage	auf Anfrage	HB2C-4-63-075T	L 0,75 kW	R-S 3-F + SP, 10A
HB2C-2-45-110T	L 1,5 kW	R-S 3-F + SP, 10A	HB2C-2-80-4500T	auf Anfrage	auf Anfrage	HB2C-4-63-110T	L 1,5 kW	R-S 3-F + SP, 10A
HB2C-2-45-150T	L 1,5 kW	R-S 3-F + SP, 10A	HB2C-2-90-3700T	auf Anfrage	auf Anfrage	HB2C-4-63-150T	L 1,5 kW	R-S 3-F + SP, 10A
HB2C-2-45-220T	L 2,2 kW	R-S 3-F + SP, 10A	HB2C-2-90-4500T	auf Anfrage	auf Anfrage	HB2C-4-71-150T	L 1,5 kW	R-S 3-F + SP, 10A
HB2C-2-50-220T	L 2,2 kW	R-S 3-F + SP, 10A	HB2C-2-90-5500T	auf Anfrage	auf Anfrage	HB2C-4-71-220T	L 2,2 kW	R-S 3-F + SP, 10A
HB2C-2-50-300T	L 4,0 kW	R-S 3-F + SP, 10A	HB2C-2-90-7500T	auf Anfrage	auf Anfrage	HB2C-4-71-300T	L 4,0 kW	R-S 3-F + SP, 10A
HB2C-2-50-400T	L 4,0 kW	R-S 3-F + SP, 10A	HB2C-2-100-7500T	auf Anfrage	auf Anfrage	HB2C-4-80-300T	L 4,0 kW	R-S 3-F + SP, 10A
HB2C-2-56-400T	L 4,0 kW	R-S 3-F + SP, 10A	HB2C-2-100-9000T	auf Anfrage	auf Anfrage	HB2C-4-80-400T	L 4,0 kW	R-S 3-F + SP, 10A
HB2C-2-56-550T	L 5,5 kW	R-S 3-F + SP, 16A	HB2C-2-100-11000T	auf Anfrage	auf Anfrage	HB2C-4-80-550T	L 5,5 kW	R-S 3-F + SP, 16A
HB2C-2-56-750T	L 7,5 kW	R-S 3-F + SP, 16A	HB2C-2-100-13200T	auf Anfrage	auf Anfrage	HB2C-4-90-400T	L 4,0 kW	R-S 3-F + SP, 10A
HB2C-2-63-550T	L 5,5 kW	R-S 3-F + SP, 16A	HB2C-4-40-012T	L 0,4 kW	R-S 3-F + SP, 10A	HB2C-4-90-550T	L 5,5 kW	R-S 3-F + SP, 16A
HB2C-2-63-750T	L 7,5 kW	R-S 3-F + SP, 16A	HB2C-4-40-018T	L 0,4 kW	R-S 3-F + SP, 10A	HB2C-4-90-750T	L 7,5 kW	R-S 3-F + SP, 16A
HB2C-2-63-1100T	L 11,0 kW	R-S 3-F + SP, 25A	HB2C-4-45-018T	L 0,4 kW	R-S 3-F + SP, 10A	HB2C-4-90-1100T	L 11,0 kW	R-S 3-F + SP, 25A
HB2C-2-63-1500T	L 15,0 kW	R-S 3-F + SP, 40A	HB2C-4-45-025T	L 0,4 kW	R-S 3-F + SP, 10A	HB2C-4-100-750T	L 7,5 kW	R-S 3-F + SP, 16A
HB2C-2-71-1100T	L 11,0 kW	R-S 3-F + SP, 25A	HB2C-4-50-025T	L 0,4 kW	R-S 3-F + SP, 10A	HB2C-4-100-1100T	L 11,0 kW	R-S 3-F + SP, 25A
HB2C-2-71-1500T	L 15,0 kW	R-S 3-F + SP, 40A	HB2C-4-50-037T	L 0,4 kW	R-S 3-F + SP, 10A	HB2C-4-100-1500T	L 15,0 kW	R-S 3-F + SP, 40A
HB2C-2-71-1850T	L 18,5 kW	R-S 3-F + SP, 40A	HB2C-4-50-055T	L 0,75 kW	R-S 3-F + SP, 10A	HB2C-4-100-1500T	L 15,0 kW	R-S 3-F + SP, 40A
HB2C-2-71-2200T	L 22,0 kW	R-S 3-F + SP, 40A	HB2C-4-56-037T	L 0,4 kW	R-S 3-F + SP, 10A			

Artikelnummer

40016450 Wandler 0,4kW	40016456 Wandler 7,5kW	91040908-01 R-S 3-F + SP, 10A
40016451 Wandler 0,75kW	40016457 Wandler 11,0kW	91040908 R-S 3-F + SP, 16A
40016452 Wandler 1,5kW	40016458 Wandler 15,0kW	91040910 R-S 3-F + SP, 25A
40016453 Wandler 2,2kW	40016459 Wandler 18,5kW	91040924 R-S 3-F + SP, 40A
40016454 Wandler 4,0kW	40016460 Wandler 22,0kW	91040911-03 R-S 3-F + SP, 63A
40016455 Wandler 5,5kW	Wandler 30,0kW	