

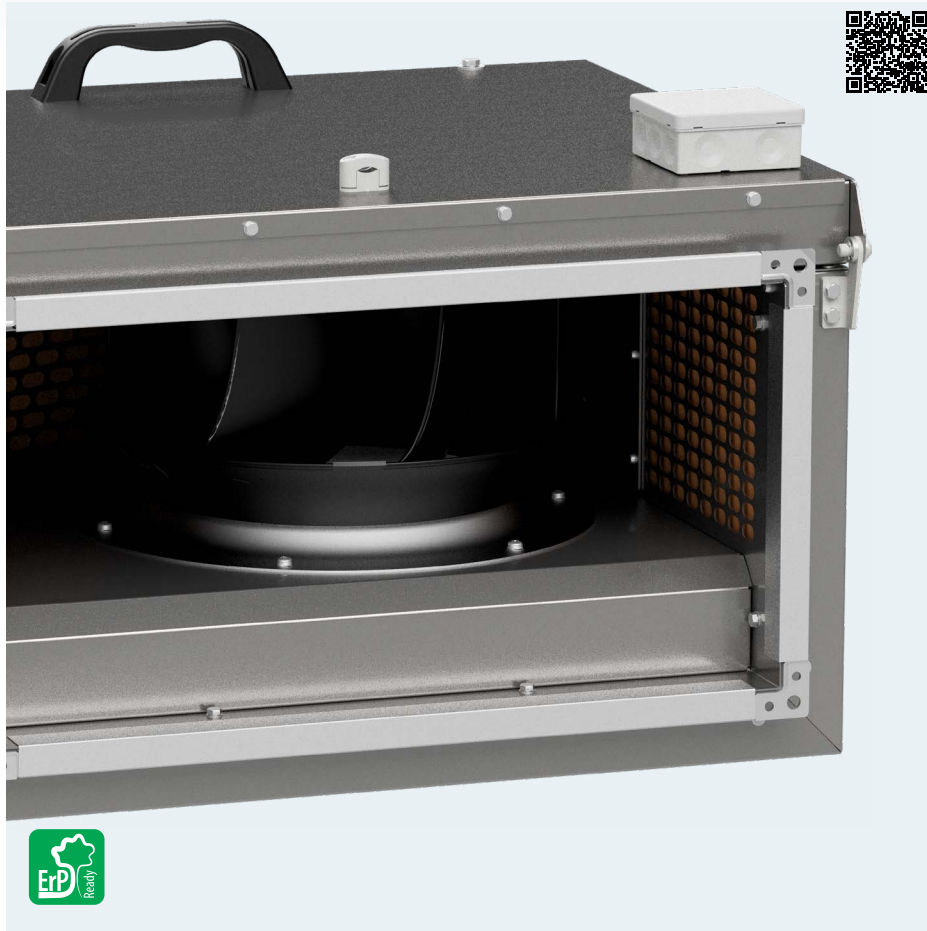

IBF-I/EC in-line duct fans

The power of AIR



Application

IBF-I EC fans are used in a wide variety of mechanical ventilation systems, combining the benefits of axial fans (flow direction) and radial (stable compression, low noise, high efficiency).

Thanks to the use of modern, high performance electronic commutation (EC) drives, fans are characterized by low power consumption. Examples of applications are supply ventilation and exhaust:

- apartments,
- offices, shops, bars, cafes, restaurants.

Construction

- housing made of galvanized steel sheet with sound insulation, class A1 fire resistance, 50mm thick,
- flanges on the inlet and outlet sides assembly,
- inspection hatch,
- rotors with backward curved blades,
- rotors are made of plastic,
- working temperature -30°C + 60°C (depending on the model),
- terminal box (single-phase model), box connected with the motor-rotor (three-phase model),
- installation in any rectangular position ventilation ducts.

Electric motor

- high efficiency motors with integrated EC technology, single-phase 200-240V 50Hz and three-phase 380-480V 50Hz, with external rotor,
- 0-10VDC control input for smooth rotation control,
- insulation class - F,
- protection rating - IP54.

Special versions

- painting in a color other than the standard,
- painting in a higher corrosivity category.



Easy assembly
Standard rectangular flanges for easy installation.

Inspection flap
For ease of use.

Rotor
with sloped blades backward.

RELATED PRODUCTS

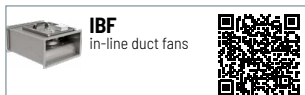



NOMINAL DATA

type	airflow max	pressure max	speed	voltage rated	current max abs.**	power max abs.	sound pressure level*	temperature operating min / max	weight	article number
IBF-I/EC-30/15S	1 050 m ³ /h	780 Pa	2 860 rpm	230 V	1,45 A	170 W	52 dB(A)	-30 / 60 °C	14,0 kg	41010809
IBF-I/EC-40/20S	1 300 m ³ /h	780 Pa	2 520 rpm	230 V	1,35 A	170 W	54 dB(A)	-30 / 60 °C	21,0 kg	41010819
IBF-I/EC-50/25S	2 400 m ³ /h	1050 Pa	3 600 rpm	230 V	4 A	780 W	58 dB(A)	-20 / 40 °C	32,0 kg	41010829
IBF-I/EC-60/35T	5 200 m ³ /h	930 Pa	2 100 rpm	400 V	2,4 A	1 350 W	61 dB(A)	-15 / 60 °C	57,0 kg	41010839
IBF-I/EC-70/40T	6 300 m ³ /h	860 Pa	1 800 rpm	400 V	2,5 A	1 450 W	68 dB(A)	-15 / 60 °C	70,0 kg	41010849
IBF-I/EC-80/50T	11 500 m ³ /h	1550 Pa	2 130 rpm	400 V	8 A	5 400 W	68 dB(A)	-20 / 40 °C	118,0 kg	41010859
IBF-I/EC-100/50T	13 000 m ³ /h	1250 Pa	1 750 rpm	400 V	8 A	5 000 W	68 dB(A)	-20 / 40 °C	135,0 kg	41010859

* Measurement made at a distance of 1.5m from the outlet, for $Q = 2/3 * Q_{max}$
 ** value of the rated current may vary depending on the manufacturer of the electric motor used.

PERFORMANCE CHARACTERISTICS OF THE FANS

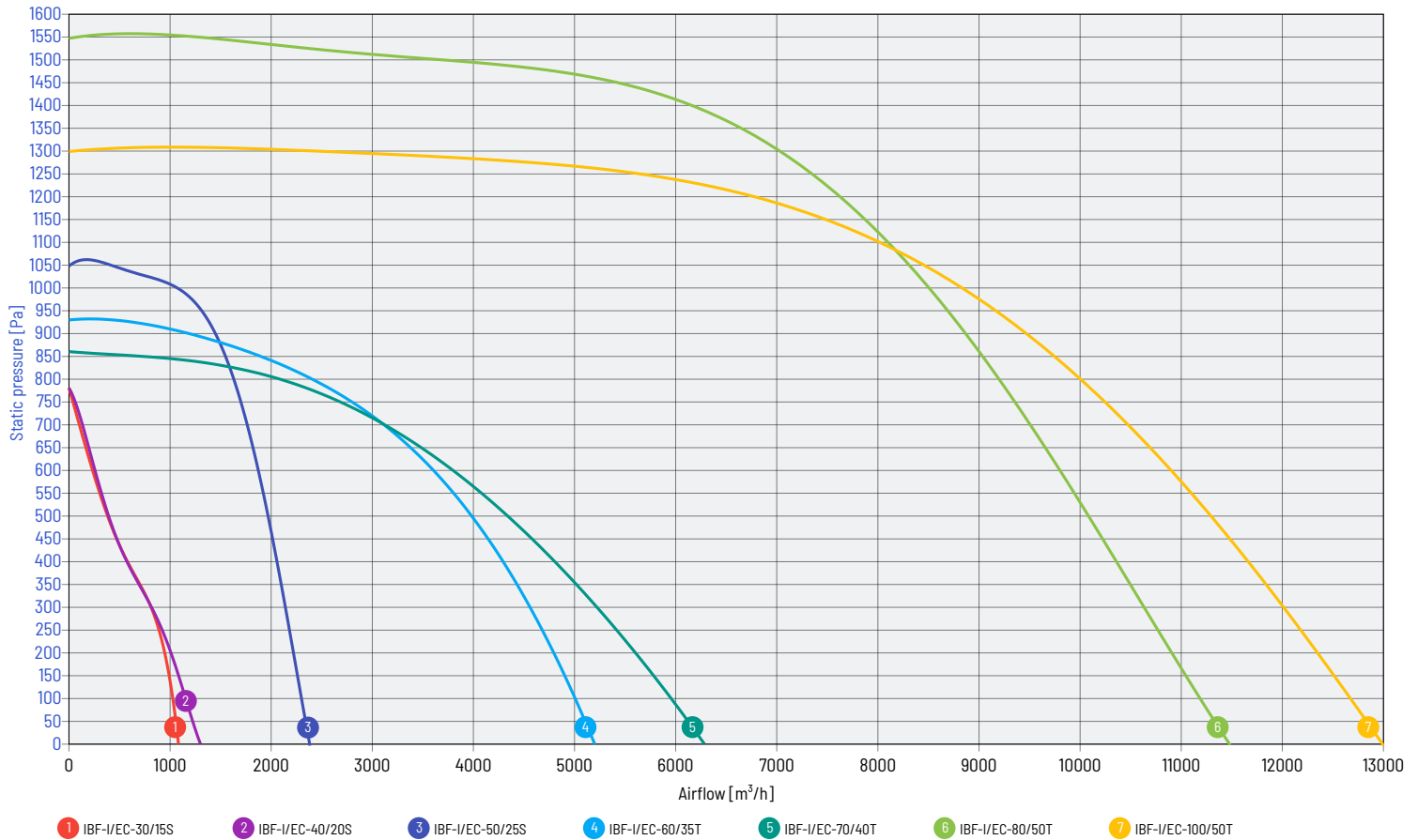



PERFORMANCE CHARACTERISTICS OF THE FANS

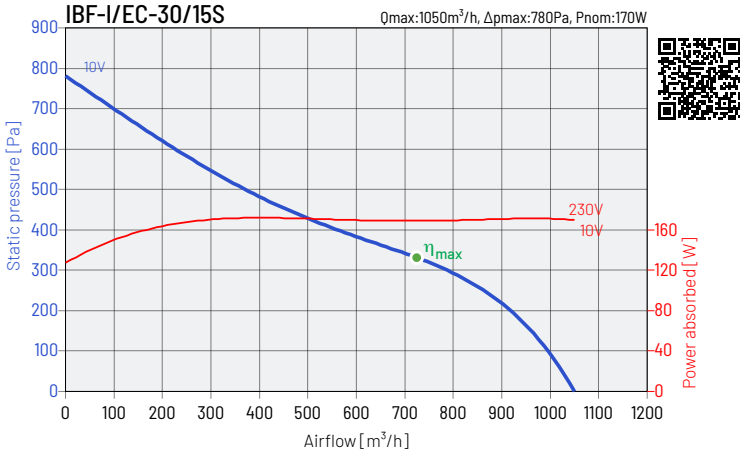

Hz / dB(A)	125	250	500	1000	2000	4000	8000	L_{WA}	L_{PA}
inlet	41	60	65	70	71	66	63	75	64
outlet	47	62	69	77	77	72	62	81	69
emitted	38	52	56	60	55	57	50	64	52

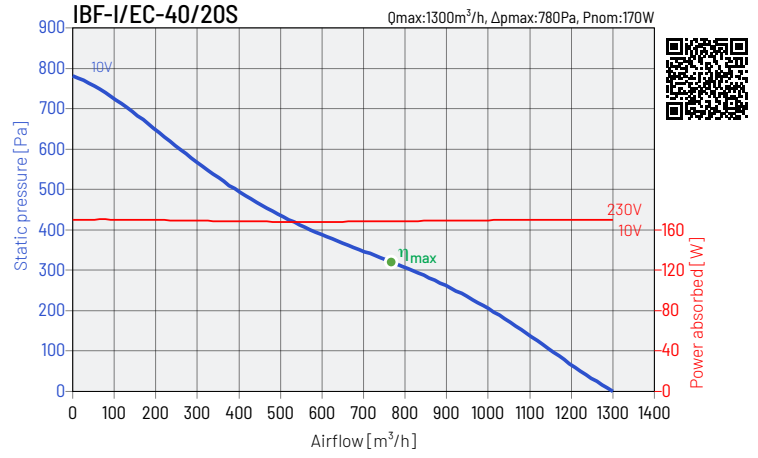

Hz / dB(A)	125	250	500	1000	2000	4000	8000	L_{WA}	L_{PA}
inlet	48	57	59	60	59	58	57	66	55
outlet	49	59	60	62	65	62	61	70	58
emitted	45	56	58	58	57	59	54	65	54

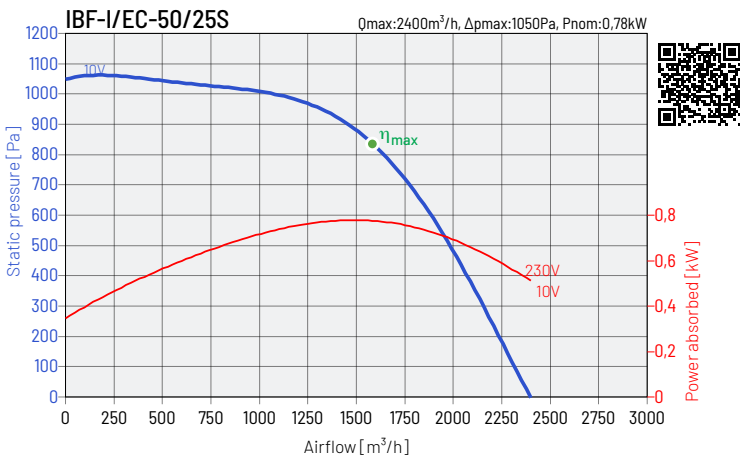

Hz / dB(A)	125	250	500	1000	2000	4000	8000	L_{WA}	L_{PA}
inlet	67	69	69	69	66	66	59	76	64
outlet	68	71	71	72	70	65	60	78	66
emitted	59	63	65	64	59	57	52	70	58

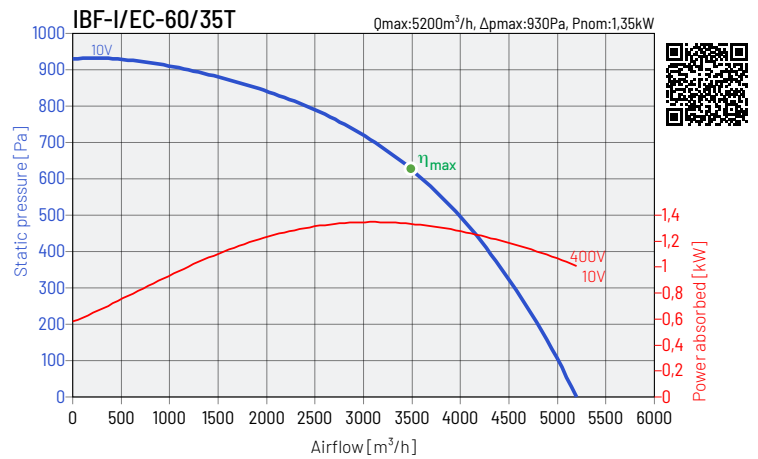

Hz / dB(A)	125	250	500	1000	2000	4000	8000	L_{WA}	L_{PA}
inlet	61	71	74	67	62	58	53	77	65
outlet	67	73	75	75	72	68	60	80	69
emitted	58	69	67	63	62	51	51	72	61

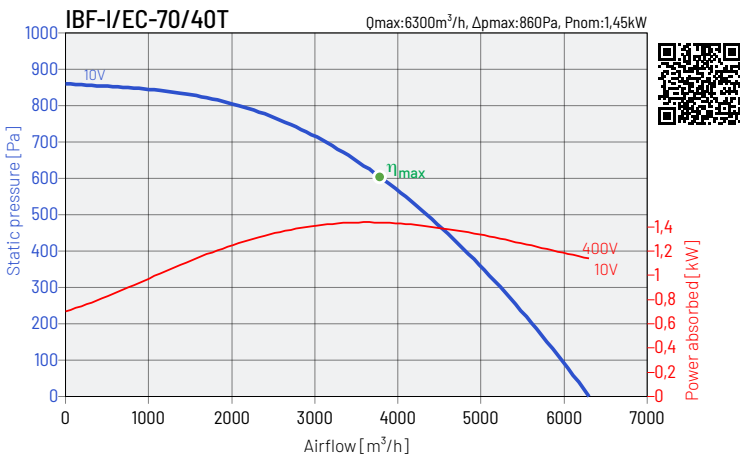

Hz / dB(A)	125	250	500	1000	2000	4000	8000	L_{WA}	L_{PA}
inlet	69	80	79	71	67	64	59	83	72
outlet	69	80	79	78	72	66	58	84	73
emitted	67	76	75	66	61	59	51	79	68

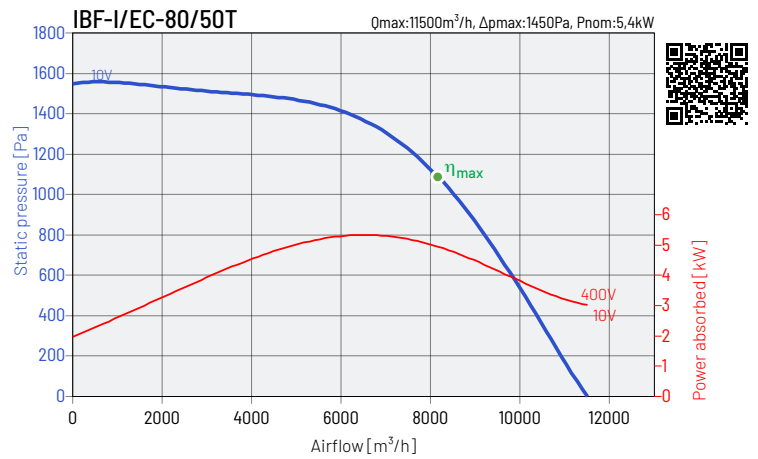

Hz / dB(A)	125	250	500	1000	2000	4000	8000	L_{WA}	L_{PA}
inlet	70	81	82	75	71	67	63	85	74
outlet	71	82	81	81	75	68	65	87	75
emitted	68	77	75	69	63	58	47	80	68

The performance characteristics of the fans are determined for a medium with a temperature of 20°C. Sound pressure level dB(A), determined at a distance of 1,5 m



PERFORMANCE CHARACTERISTICS OF THE FANS

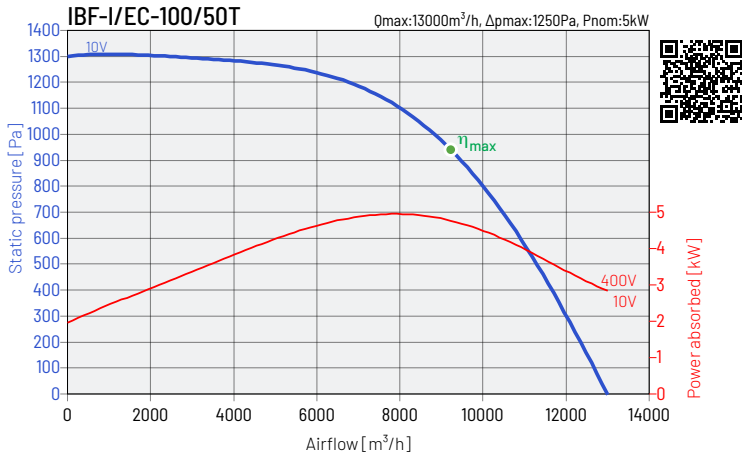

Hz / dB(A)	125	250	500	1000	2000	4000	8000	L _{WA}	L _{PA}
inlet	73	74	78	79	76	70	63	84	72
outlet	75	77	79	79	76	75	63	85	73
emitted	66	71	76	73	69	67	61	79	68

The performance characteristics of the fans are determined for a medium with a temperature of 20°C. Sound pressure level dB (A), determined at a distance of 1.5 m



ECO PROJECT

Type	IBF-I/EC-30/15S	IBF-I/EC-40/20S	IBF-I/EC-50/25S	IBF-I/EC-60/35T
a Supplier name	VENTURE INDUSTRIES	VENTURE INDUSTRIES	VENTURE INDUSTRIES	VENTURE INDUSTRIES
b Article number	41010809	41010819	41010829	41010839
c Device category	NRVU	NRVU	NRVU	NRVU
c Device type	UVU	UVU	UVU	UVU
d Type of drive	variable speed drive v	variable speed drive v	variable speed drive v	variable speed drive v
e Type of heat recovery system	not applicable	not applicable	not applicable	not applicable
f Thermal efficiency of heat recovery [%]	not applicable	not applicable	not applicable	not applicable
g Reference flow rate in NRVU [m ³ /s]	0,21	0,22	0,5	0,86
h Electric power input [kW]	0,17	0,17	0,74	1,35
i SFPint [W/(m ² /s)]	816	760	1480	1567
j Face velocity [m/s]	1,21	1,13	2,2	2,62
k Δps, ext [Pa]	315	307	703	701
l Δps, int [Pa]	not applicable	not applicable	not applicable	not applicable
m Δps, add [Pa]	not applicable	not applicable	not applicable	not applicable
n Static efficiency of fans [%]	38,6	40,4	47,5	44,7
o Maximum external leakage rate [%]	0	0	0	0
p Energy performance	not applicable	not applicable	not applicable	not applicable
q Visual filter warning	not applicable	not applicable	not applicable	not applicable
r L _{WA} [dB(A)]	64	65	70	72
s Internet address	www.ventur.eu	www.ventur.eu	www.ventur.eu	www.ventur.eu

Type	IBF-I/EC-70/40T	IBF-I/EC-80/50T	IBF-I/EC-100/50T
a Supplier name	VENTURE INDUSTRIES	VENTURE INDUSTRIES	VENTURE INDUSTRIES
b Article number	41010849	41010859	41010859
c Device category	NRVU	NRVU	NRVU
c Device type	UVU	UVU	UVU
d Type of drive	variable speed drive v	variable speed drive v	variable speed drive v
e Type of heat recovery system	not applicable	not applicable	not applicable
f Thermal efficiency of heat recovery [%]	not applicable	not applicable	not applicable
g Reference flow rate in NRVU [m ³ /s]	1,11	2,37	2,78
h Electric power input [kW]	1,41	4,62	4,42
i SFPint [W/(m ² /s)]	1270	1952	1590
j Face velocity [m/s]	3,01	5,2	5,49
k Δps, ext [Pa]	567	1007	817
l Δps, int [Pa]	not applicable	not applicable	not applicable
m Δps, add [Pa]	not applicable	not applicable	not applicable
n Static efficiency of fans [%]	44,6	51,6	51,4
o Maximum external leakage rate [%]	0	0	0
p Energy performance	not applicable	not applicable	not applicable
q Visual filter warning	not applicable	not applicable	not applicable
r L _{WA} [dB(A)]	79	80	79
s Internet address	www.ventur.eu	www.ventur.eu	www.ventur.eu



DIMENSIONS

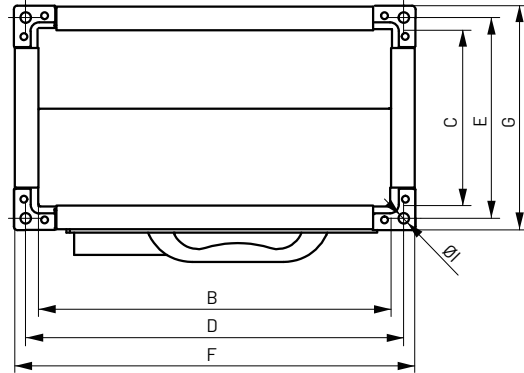
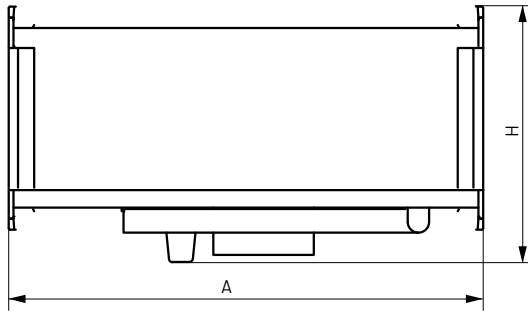

type	A mm	B mm	C mm	D mm	E mm	F mm	G mm	H mm	Ø1 mm
IBF-I/EC-30/15S	402	300	150	320	170	410	260	304	9
IBF-I/EC-40/20S	502	400	200	420	220	510	310	354	9
IBF-I/EC-50/25S	532	500	250	520	270	610	360	404	9
IBF-I/EC-60/35T	724	600	350	620	370	710	460	504	9

type	A mm	B mm	C mm	D mm	E mm	F mm	G mm	H mm	Ø1 mm
IBF-I/EC-70/40T	724	700	400	722	420	812	510	554	9
IBF-I/EC-80/50T	880	800	500	822	522	912	612	656	9
IBF-I/EC-100/50T	1000	1000	500	1029	529	1112	612	656	13

MOUNTING ACCESSORIES

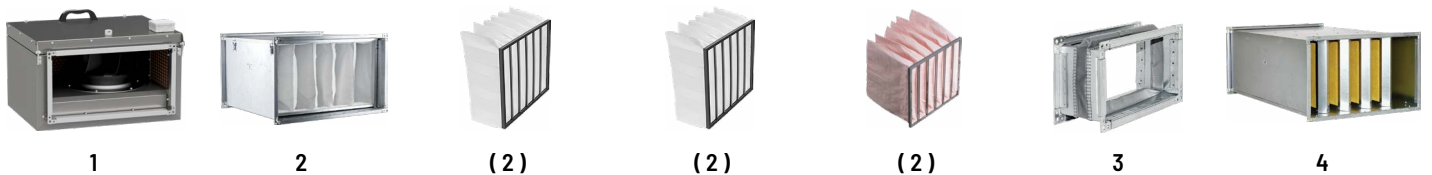
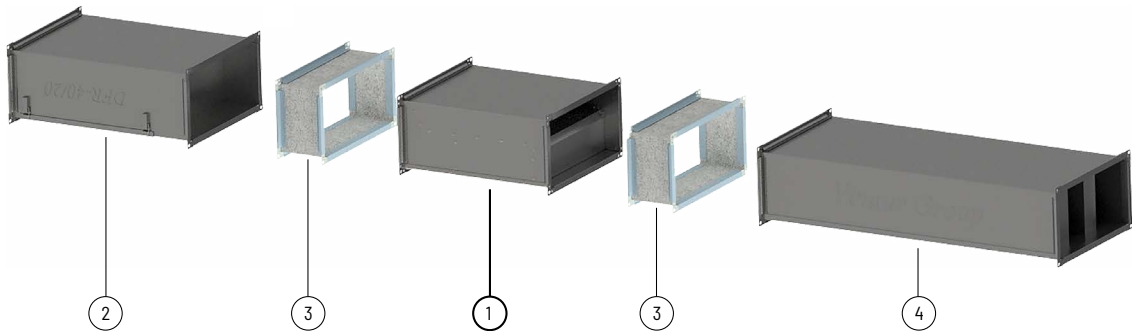

type	duct filter DFR	cartridge filter EU3	cartridge filter EU5	cartridge filter EU7	antivibration connector IAE-PL	silencer RCS
IBF-I/EC-30/15S	DFR-30/15	EU3 30/15 cm	EU5 30/15 cm	EU7 30/15 cm	IAE-PL-190	RCS-30/15
IBF-I/EC-40/20S	DFR-40/20	EU3 40/20 cm	EU5 40/20 cm	EU7 40/20 cm	IAE-PL-200	RCS-40/20
IBF-I/EC-50/25S	DFR-50/25	EU3 50/25 cm	EU5 50/25 cm	EU7 50/25 cm	IAE-PL-225	RCS-50/25
IBF-I/EC-60/35T	DFR-60/35	EU3 60/35 cm	EU5 60/35 cm	EU7 60/35 cm	IAE-PL-315	RCS-60/35
IBF-I/EC-70/40T	DFR-70/40	EU3 70/40 cm	EU5 70/40 cm	EU7 70/40 cm	IAE-PL-355	RCS-70/40
IBF-I/EC-80/50T	DFR-80/50	EU3 80/50 cm	EU5 80/50 cm	EU7 80/50 cm	IAE-PL-400	RCS-80/50
IBF-I/EC-100/50T	DFR-100/50	EU3 100/50 cm	EU5 100/50 cm	EU7 100/50 cm	IAE-PL-450	RCS-100/50

Article numbers

40520910 DFR-30/15	40520913 EU3 30/15cm	40520915 EU5 30/15cm	40520917 EU7 30/15cm	40532800 IAE-PL-190	40521900 RCS-30/15
40520920 DFR-40/20	40520923 EU3 40/20cm	40520925 EU5 40/20cm	40520927 EU7 40/20cm	40532810 IAE-PL-200	40521910 RCS-40/20
40520930 DFR-50/25	40520933 EU3 50/25cm	40520935 EU5 50/25cm	40520937 EU7 50/25cm	40532820 IAE-PL-225	40521920 RCS-50/25
40520960 DFR-60/35	40520963 EU3 60/35cm	40520965 EU5 60/35cm	40520967 EU7 60/35cm	40532850 IAE-PL-315	40521950 RCS-60/35
40520970 DFR-70/40	40520973 EU3 70/40cm	40520975 EU5 70/40cm	40520977 EU7 70/40cm	40532860 IAE-PL-355	40521960 RCS-70/40
40520980 DFR-80/50	40520983 EU3 80/50cm	40520985 EU5 80/50cm	40520987 EU7 80/50cm	40532870 IAE-PL-400	40521970 RCS-80/50
40520990 DFR-100/50	40520993 EU3 100/50cm	40520995 EU5 100/50cm	40520997 EU7 100/50cm	40532880 IAE-PL-450	40521980 RCS-100/50



ELECTRICAL ACCESSORIES



type	wall thermostat	duct thermostat	air quality sensor	humidistat	thyristor regulator	signal converter
	TS	TK-21	SQA	HIG-2	REB-ECOWATT	MODBUS
IBF-I/EC-30/15S	TS	TK-21	SQA	HIG-2	REB-ECOWATT	MDACM1
IBF-I/EC-40/20S	TS	TK-21	SQA	HIG-2	REB-ECOWATT	MDACM1
IBF-I/EC-50/25S	TS	TK-21	SQA	HIG-2	REB-ECOWATT	built in
IBF-I/EC-60/35T	TS + DILM7-10	TK-21+ DILM7-10	SQA + DILM7-10	HIG-2 + DILM7-10	REB-ECOWATT	MDACM1
IBF-I/EC-70/40T	TS + DILM7-10	TK-21+ DILM7-10	SQA + DILM7-10	HIG-2 + DILM7-10	REB-ECOWATT	MDACM1
IBF-I/EC-80/50T	TS + DILM12-10	TK-21+ DILM12-10	SQA + DILM12-10	HIG-2 + DILM12-10	REB-ECOWATT	built in
IBF-I/EC-100/50T	TS + DILM12-10	TK-21+ DILM12-10	SQA + DILM12-10	HIG-2 + DILM12-10	REB-ECOWATT	built in

Article numbers

40025345 TS
40025320 TK-21

40025140 SQA
40025150 HIG-2

40025005 REB-ECOWATT

40025287 MDACM1

91040997 DILM7-10
91040666-41 DILM12-10