

Application

Roof exhaust fans are designed for ventilation systems of buildings with a low degree of air pollution.

They are used, among others, in:

- building exhaust systems residential, supermarkets,
- industrial halls, workshops, warehouses, toilets,
- garages, parking lots, farm buildings and others...

Construction

- rotor with backward curved blades, made of plastic or aluminum sheet (depending on the model),
- base made of aluminum sheet,
- housing made of aluminum sheet,
- bowl made of aluminum sheet,
- protective mesh made of galvanized sheet steel,
- adapted to work in a vertical position,
- installation on flat roofs,
- operating temperature from -40°C to +70°C, depending on the model.

Motor

- asynchronous, single-phase, 1 ~ 230V, 50Hz external rotor induction motor,
- asynchronous, three-phase, 400V, 50Hz external rotor induction motor,
- adapted to smooth regulation rotational speed,
- thermal protection against overload.



Protective mesh

Easy access to the terminal box

RELATED PRODUCTS



RF/EC
Roof fan with horizontal outlet



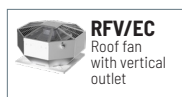

RFV
Roof fan with vertical outlet

RFV/EC
Roof fan with vertical outlet



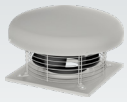

NOMINAL DATA

type	airflow max	pressure max	speed	voltage rated	current max absorbed**	power max absorbed	sound pressure level*	temp. operating min / max	weight	article number
RF/2-125S	480 m ³ /h	325 Pa	2 640 rpm	1~230 V	0,38 A	50 W	63 dB(A)	-40 / 70 °C	3,5 kg	43528010
RF/4-125S	260 m ³ /h	85 Pa	1 430 rpm	1~230 V	0,2 A	39 W	46 dB(A)	-40 / 60 °C	3,5 kg	43528015
RF/2-160S	880 m ³ /h	400 Pa	2 700 rpm	1~230 V	0,4 A	101 W	66 dB(A)	-40 / 65 °C	4,0 kg	43528031
RF/2-160S/H	1 220 m ³ /h	518 Pa	2 730 rpm	1~230 V	0,7 A	150 W	65 dB(A)	-40 / 70 °C	4,0 kg	43528033
RF/4-160S	604 m ³ /h	139 Pa	1 425 rpm	1~230 V	0,2 A	39 W	65 dB(A)	-40 / 70 °C	4,0 kg	43528036
RF/4-160S/L	470 m ³ /h	120 Pa	1 412 rpm	1~230 V	0,2 A	34 W	53 dB(A)	-40 / 55 °C	3,3 kg	43528037
RF/2-200S	1 560 m ³ /h	630 Pa	2 762 rpm	1~230 V	1,2 A	271 W	62 dB(A)	-40 / 70 °C	6,9 kg	43528040
RF/4-200S	1 120 m ³ /h	207 Pa	1 400 rpm	1~230 V	0,4 A	99 W	53 dB(A)	-40 / 55 °C	6,4 kg	43528050
RF/4-250S	1 570 m ³ /h	177 Pa	1 430 rpm	1~230 V	0,69 A	132 W	51 dB(A)	-40 / 65 °C	9,0 kg	43528060
RF/4-250T	1 520 m ³ /h	239 Pa	1 400 rpm	3~400 V	0,33 A	139 W	52 dB(A)	-40 / 60 °C	9,0 kg	43528080
RF/6-250S	895 m ³ /h	120 Pa	960 rpm	1~230 V	0,2 A	47 W	42 dB(A)	-40 / 60 °C	9,0 kg	43528100
RF/4-315S	2 430 m ³ /h	219 Pa	1 370 rpm	1~230 V	1,1 A	220 W	55 dB(A)	-40 / 60 °C	10,0 kg	43528070
RF/4-315T	3 300 m ³ /h	290 Pa	1 380 rpm	3~400 V	0,68 A	330 W	58 dB(A)	-40 / 60 °C	11,0 kg	43528090
RF/6-315S	1 750 m ³ /h	131 Pa	950 rpm	1~230 V	0,33 A	70 W	45 dB(A)	-40 / 60 °C	9,5 kg	43528110
RF/4-355S	3 750 m ³ /h	405 Pa	1 398 rpm	1~230 V	2,3 A	540 W	69 dB(A)	-40 / 60 °C	19,0 kg	43528120
RF/4-355T	3 700 m ³ /h	400 Pa	1 352 rpm	3~400Δ V	1,0 A	440 W	67 dB(A)	-40 / 60 °C	19,0 kg	43528125
	3 100 m ³ /h	300 Pa	1 106 rpm	3~400Y V	0,54 A	310 W	62 dB(A)			
RF/6-355T	2 700 m ³ /h	190 Pa	962 rpm	3~400Δ V	0,47 A	180 W	58 dB(A)	-40 / 70 °C	19,0 kg	43528135
	2 200 m ³ /h	150 Pa	807 rpm	3~400Y V	0,2 A	110 W	55 dB(A)			
RF/4-400S	5 000 m ³ /h	330 Pa	1 270 rpm	1~230 V	2,6 A	580 W	70 dB(A)	-40 / 60 °C	23,0 kg	43528140
RF/4-400T	5 000 m ³ /h	500 Pa	1 408 rpm	3~400Δ V	1,3 A	640 W	71 dB(A)	-40 / 70 °C	22,0 kg	43528142
	4 300 m ³ /h	440 Pa	1 140 rpm	3~400Y V	0,8 A	460 W	69 dB(A)			
RF/6-400S	2 900 m ³ /h	210 Pa	931 rpm	1~230 V	0,7 A	180 W	64 dB(A)	-40 / 70 °C	22,0 kg	43528145
RF/6-400T	3 850 m ³ /h	260 Pa	952 rpm	3~400Δ V	0,59 A	270 W	61 dB(A)	-40 / 70 °C	21,0 kg	43528146
	3 300 m ³ /h	170 Pa	690 rpm	3~400Y V	0,3 A	165 W	56 dB(A)			
RF/4-450S	7 700 m ³ /h	700 Pa	1 390 rpm	1~230 V	5,3 A	1 270 W	72 dB(A)	-40 / 60 °C	35,0 kg	43528150
RF/4-450T/L	6 850 m ³ /h	610 Pa	1 388 rpm	3~400Δ V	2,0 A	1 020 W	75 dB(A)	-40 / 70 °C	32,0 kg	43528151
	5 800 m ³ /h	500 Pa	982 rpm	3~400Y V	1,2 A	700 W	71 dB(A)			
RF/4-450T/H	7 400 m ³ /h	440 Pa	1 370 rpm	3~400 V	3,4 A	1 000 W	76 dB(A)	-40 / 60 °C	29,0 kg	43528152
RF/6-450T	4 800 m ³ /h	280 Pa	912 rpm	3~400Δ V	0,8 A	410 W	63 dB(A)	-40 / 80 °C	25,0 kg	43528155
	4 000 m ³ /h	170 Pa	660 rpm	3~400Y V	0,4 A	225 W	60 dB(A)			
RF/4-500T/L	7 800 m ³ /h	690 Pa	1 360 rpm	3~400 V	2,8 A	1 250 W	72 dB(A)	-40 / 60 °C	43,0 kg	43528161
RF/6-500S/L	5 800 m ³ /h	330 Pa	925 rpm	1~230 V	2,2 A	490 W	69 dB(A)	-40 / 60 °C	36,0 kg	43528162
RF/6-500S/H	6 600 m ³ /h	225 Pa	900 rpm	1~230 V	2,5 A	540 W	66 dB(A)	-40 / 60 °C	40,0 kg	43528165
RF/6-500T	5 200 m ³ /h	290 Pa	920 rpm	3~400 V	0,8 A	390 W	65 dB(A)	-40 / 60 °C	36,0 kg	43528164
RF/4-560T/L	13 800 m ³ /h	880 Pa	1 364 rpm	3~400Δ V	4,9 A	2 770 W	75 dB(A)	-40 / 40 °C	55,0 kg	43528170
	11 000 m ³ /h	625 Pa	975 rpm	3~400Y V	2,74 A	1 540 W	68 dB(A)			
RF/4-560T/H	14 600 m ³ /h	640 Pa	1 333 rpm	3~400 V	4,6 A	2 513 W	75 dB(A)	-40 / 45 °C	51,0 kg	43528172
RF/6-560S	9 800 m ³ /h	285 Pa	890 rpm	1~230 V	4,2 A	840 W	65 dB(A)	-40 / 60 °C	48,0 kg	43528174
RF/6-560T	10 000 m ³ /h	400 Pa	966 rpm	3~400Δ V	1,9 A	910 W	68 dB(A)	-40 / 70 °C	48,0 kg	43528176
	8 800 m ³ /h	300 Pa	743 rpm	3~400Y V	1,0 A	570 W	63 dB(A)			
RF/4-630T	21 000 m ³ /h	825 Pa	1 270 rpm	3~400 V	6,6 A	3 900 W	72 dB(A)	-40 / 55 °C	72,0 kg	43528185

* Measurement made at a distance of 1.5m from the outlet, for Q = 2/3 * Qmax
 ** value of the rated current may vary depending on the manufacturer of the electric motor used.

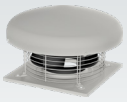

PERFORMANCE CHARACTERISTICS OF THE FANS - 2-POLE MOTORS

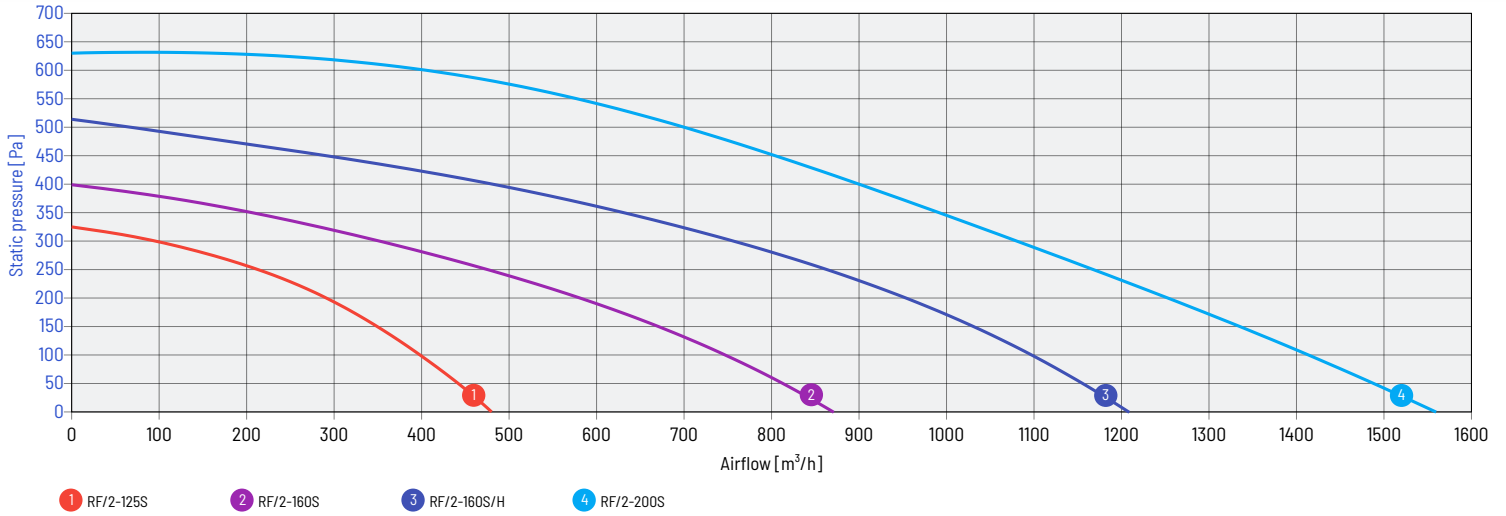

PERFORMANCE CHARACTERISTICS OF THE FANS - 4-POLE MOTORS

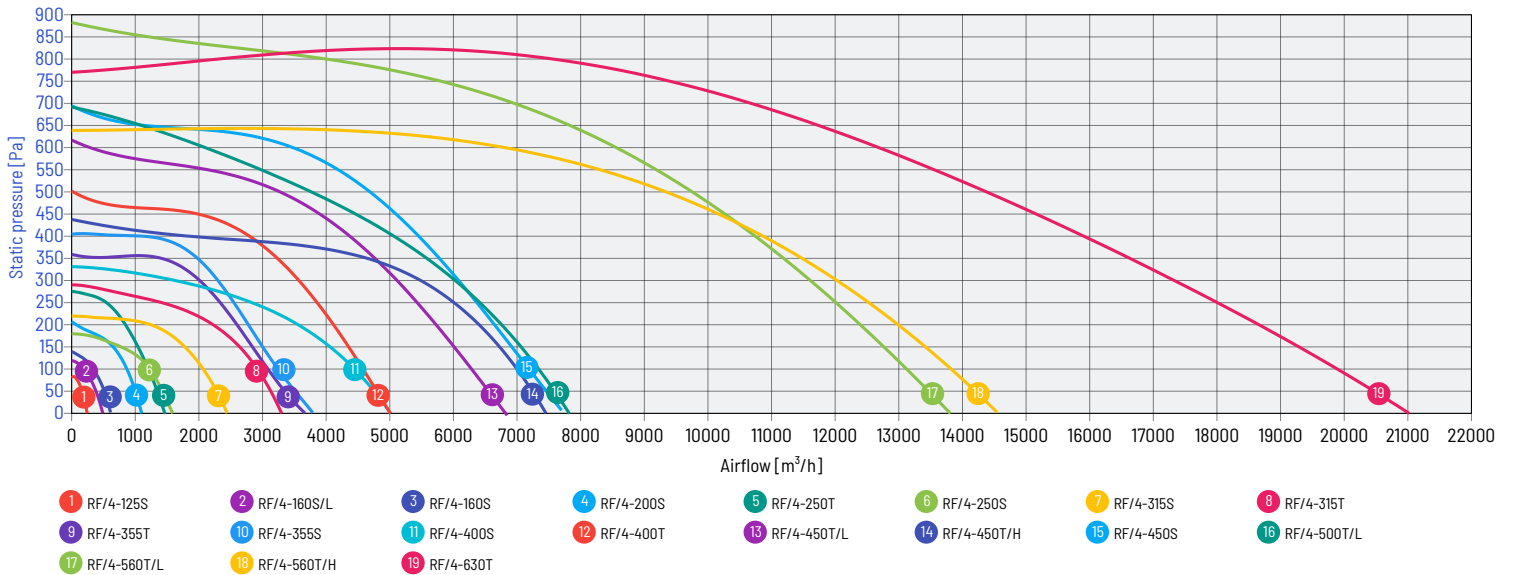

PERFORMANCE CHARACTERISTICS OF THE FANS - 6-POLE MOTORS

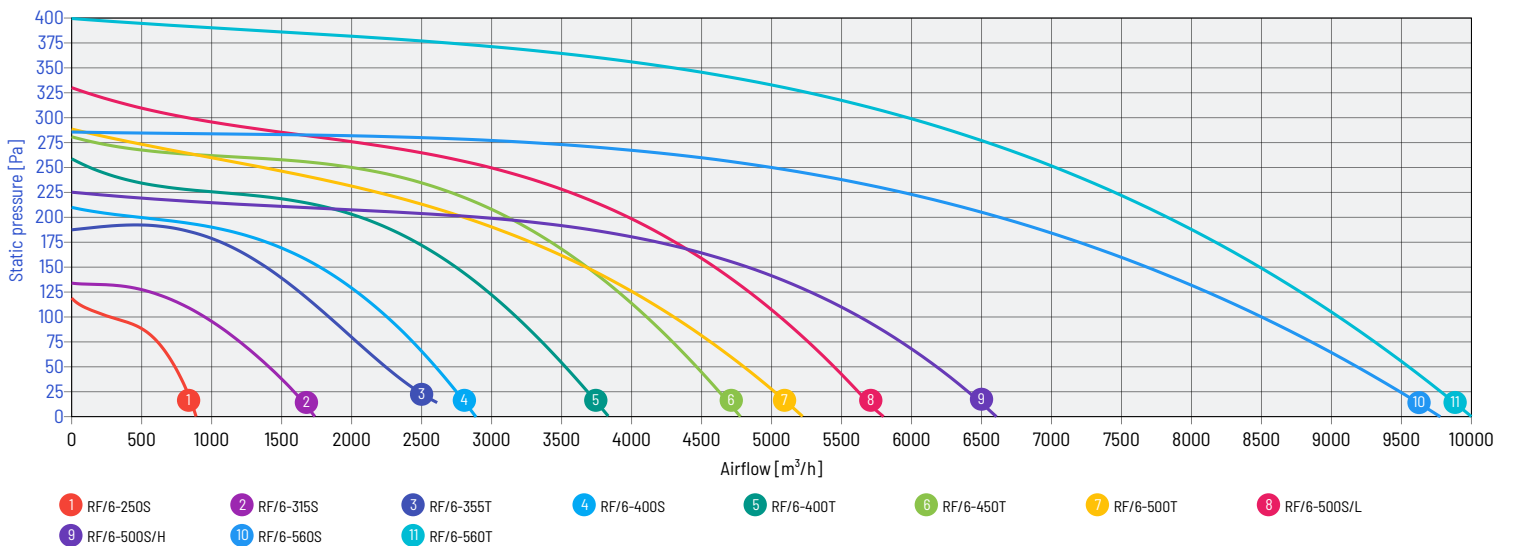

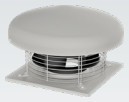

PERFORMANCE CHARACTERISTICS OF THE FANS

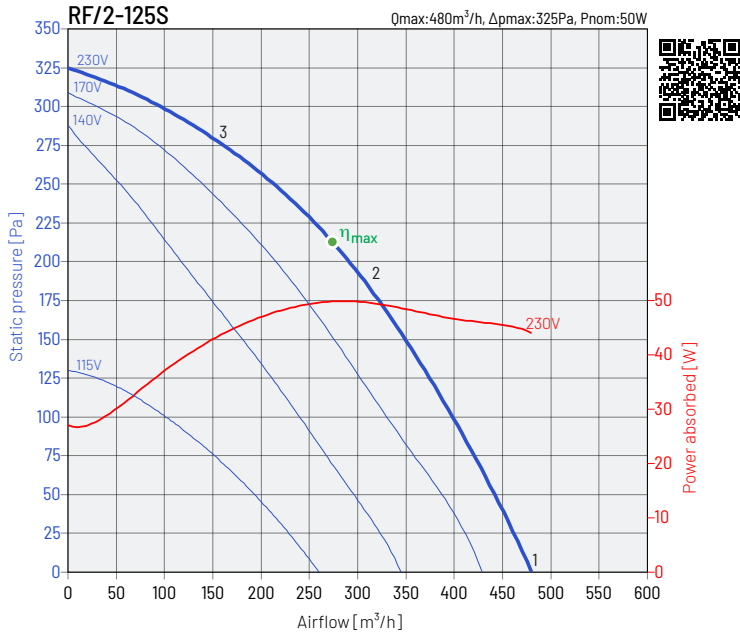

working point	63 Hz	125 Hz	250 Hz	500 Hz	1000 Hz	2000 Hz	4000 Hz	8000 Hz	L_{WA}
1	inlet								
	outlet	41	52	61	64	67	63	49	70
2	inlet								
	outlet	38	51	59	61	63	57	45	67
3	inlet								
	outlet	38	56	64	62	62	56	45	68

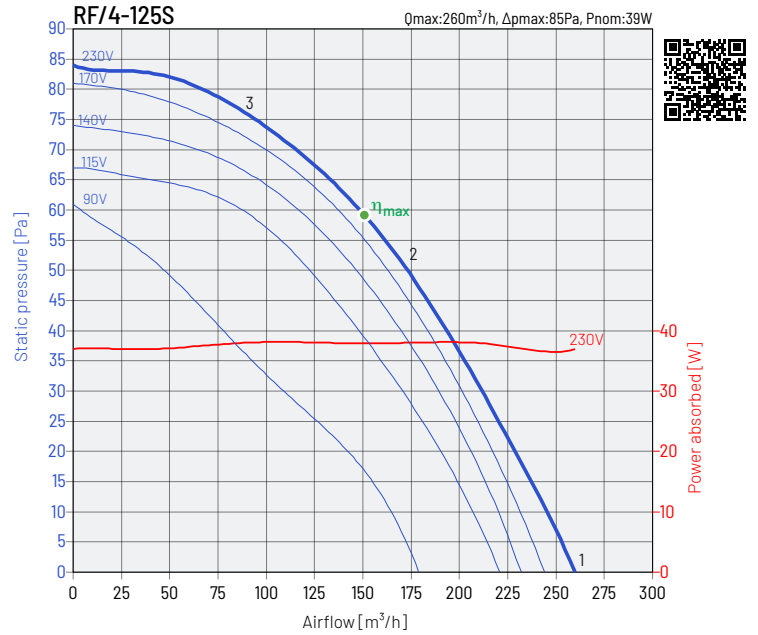

working point	63 Hz	125 Hz	250 Hz	500 Hz	1000 Hz	2000 Hz	4000 Hz	8000 Hz	L_{WA}
1	inlet								
	outlet	30	39	45	47	51	37	23	53
2	inlet								
	outlet	29	38	43	46	43	33	19	49
3	inlet								
	outlet	32	42	43	46	43	33	19	50

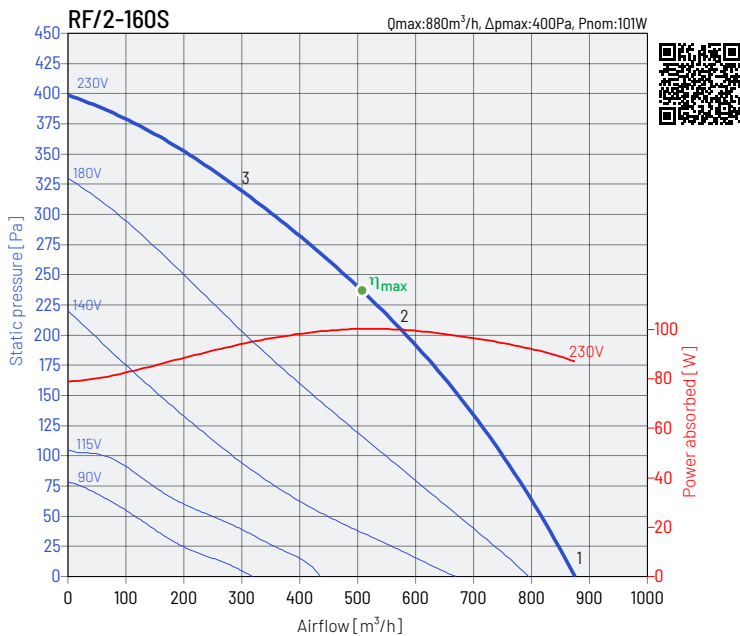

working point	63 Hz	125 Hz	250 Hz	500 Hz	1000 Hz	2000 Hz	4000 Hz	8000 Hz	L_{WA}
1	inlet								
	outlet	46	56	66	68	69	63	54	73
2	inlet								
	outlet	46	55	63	65	65	59	44	70
3	inlet								
	outlet	50	60	62	64	66	60	47	70

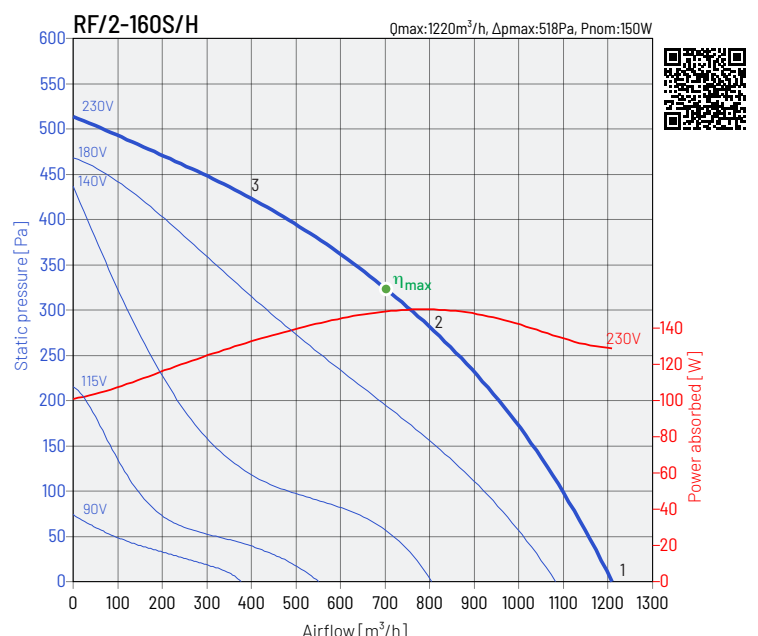

working point	63 Hz	125 Hz	250 Hz	500 Hz	1000 Hz	2000 Hz	4000 Hz	8000 Hz	L_{WA}
1	inlet								
	outlet	41	58	60	65	66	63	53	70
2	inlet								
	outlet	40	56	57	61	61	55	49	66
3	inlet								
	outlet	50	57	59	62	62	55	47	67

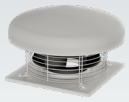

PERFORMANCE CHARACTERISTICS OF THE FANS

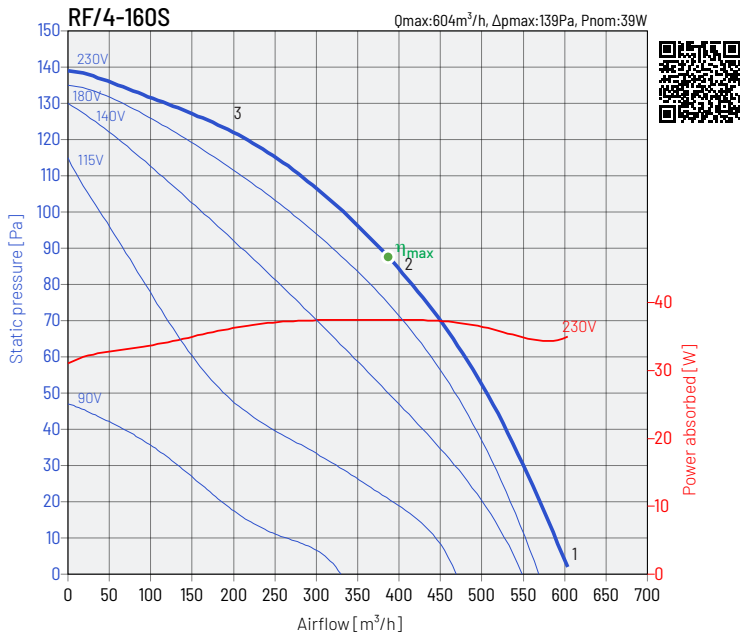

working point	63 Hz	125 Hz	250 Hz	500 Hz	1000 Hz	2000 Hz	4000 Hz	8000 Hz	L _{WA}
1	inlet								
	outlet	47	55	57	59	60	56	47	65
2	inlet								
	outlet	47	53	55	57	57	51	44	62
3	inlet								
	outlet	53	55	55	56	56	49	41	62

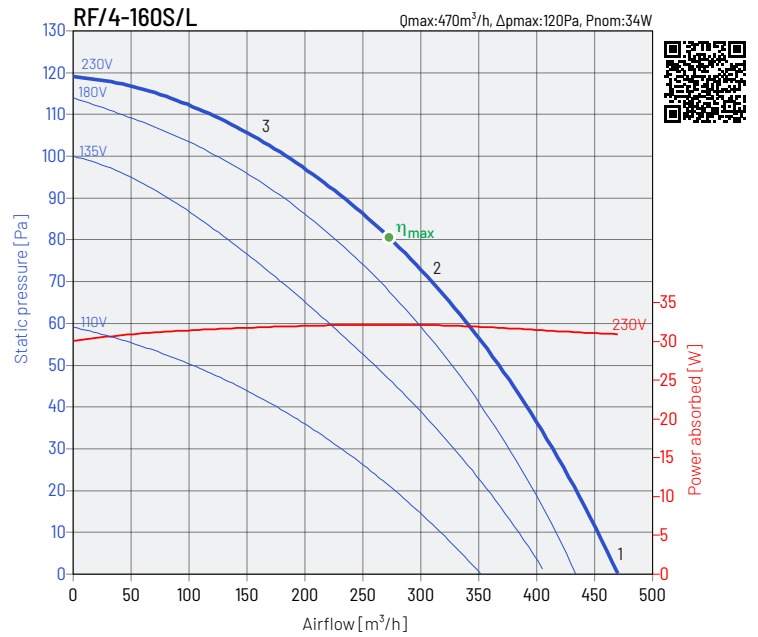

working point	63 Hz	125 Hz	250 Hz	500 Hz	1000 Hz	2000 Hz	4000 Hz	8000 Hz	L _{WA}
1	inlet								
	outlet	47	52	55	57	58	55	44	63
2	inlet								
	outlet	43	51	54	56	56	51	42	61
3	inlet								
	outlet	47	50	52	54	54	48	40	59

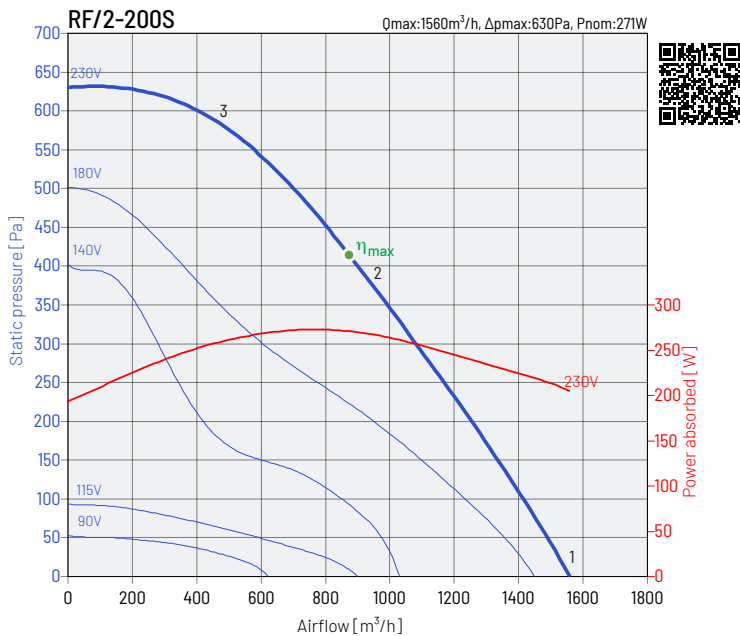

working point	63 Hz	125 Hz	250 Hz	500 Hz	1000 Hz	2000 Hz	4000 Hz	8000 Hz	L _{WA}
1	inlet								
	outlet	44	70	70	72	72	66	62	78
2	inlet								
	outlet	50	64	68	69	67	62	55	74
3	inlet								
	outlet	54	68	69	71	70	63	57	76

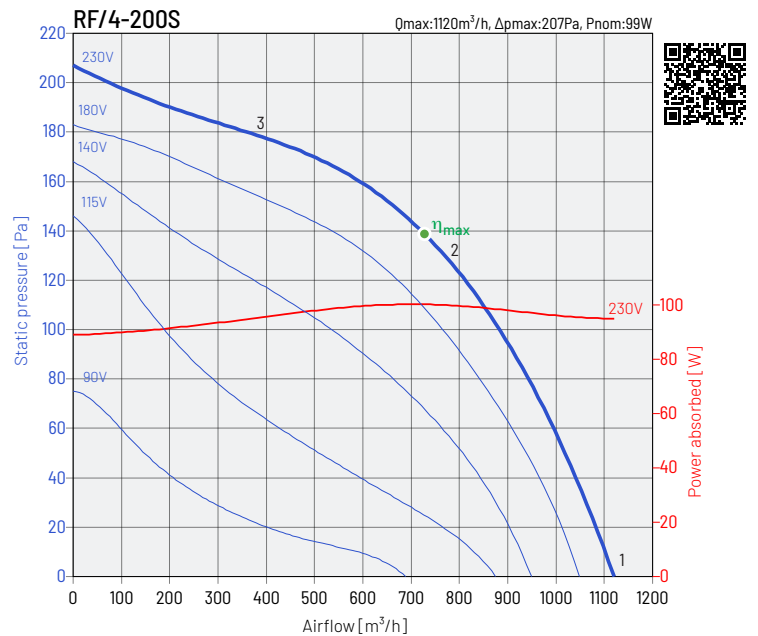

working point	63 Hz	125 Hz	250 Hz	500 Hz	1000 Hz	2000 Hz	4000 Hz	8000 Hz	L _{WA}
1	inlet								
	outlet	44	54	58	61	62	55	43	66
2	inlet								
	outlet	44	54	59	59	59	50	40	64
3	inlet								
	outlet	46	49	53	56	57	48	38	61

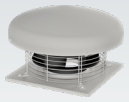

PERFORMANCE CHARACTERISTICS OF THE FANS

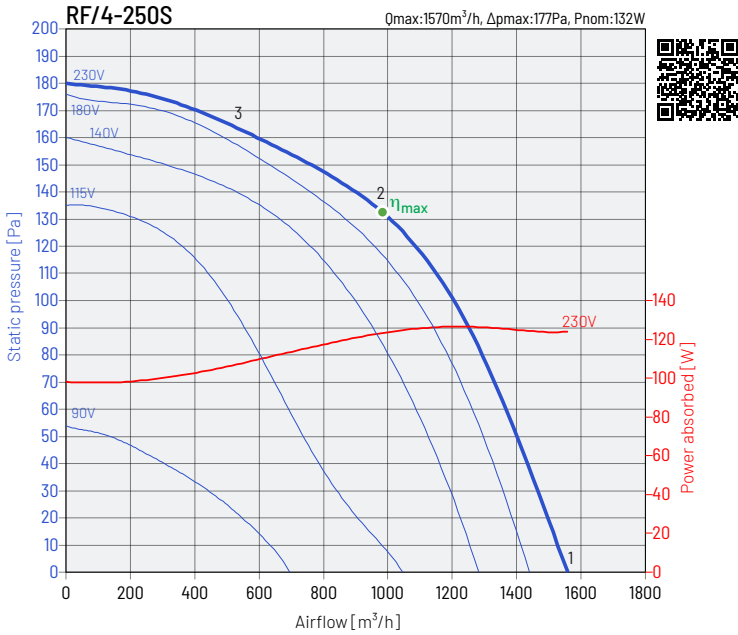

working point	63 Hz	125 Hz	250 Hz	500 Hz	1000 Hz	2000 Hz	4000 Hz	8000 Hz	L_{WA}
1	inlet								
	outlet	49	56	61	62	60	55	44	67
2	inlet								
	outlet	47	53	57	57	55	47	35	62
3	inlet								
	outlet	45	50	55	55	52	45	33	60

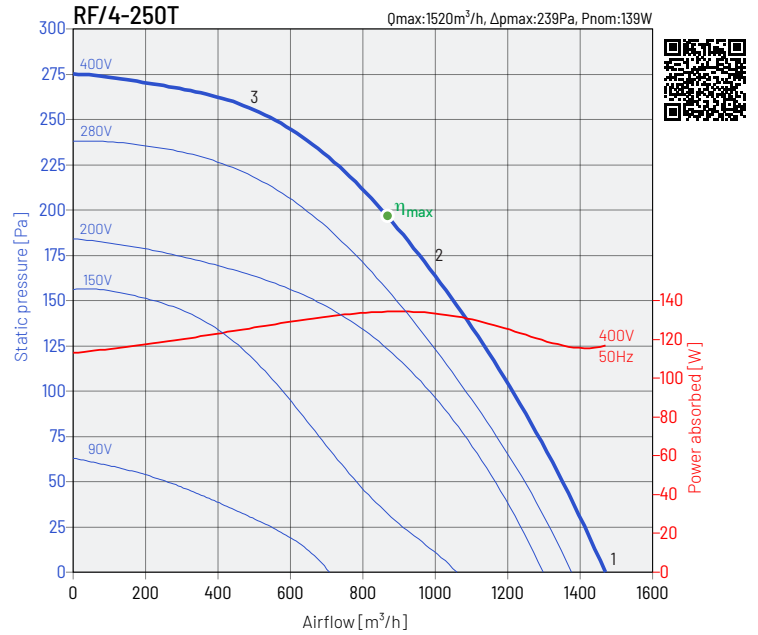

working point	63 Hz	125 Hz	250 Hz	500 Hz	1000 Hz	2000 Hz	4000 Hz	8000 Hz	L_{WA}
1	inlet								
	outlet	52	57	62	63	58	55	38	67
2	inlet								
	outlet	48	53	58	59	54	47	34	63
3	inlet								
	outlet	48	53	58	59	54	47	35	63

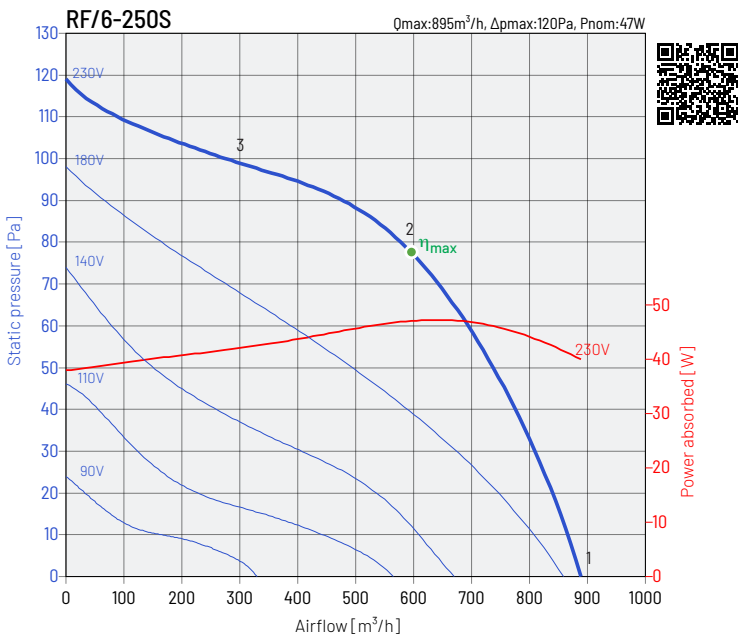

working point	63 Hz	125 Hz	250 Hz	500 Hz	1000 Hz	2000 Hz	4000 Hz	8000 Hz	L_{WA}
1	inlet								
	outlet	41	47	51	51	50	35	24	56
2	inlet								
	outlet	37	43	49	49	44	31	20	53
3	inlet								
	outlet	37	43	48	49	43	31	21	53

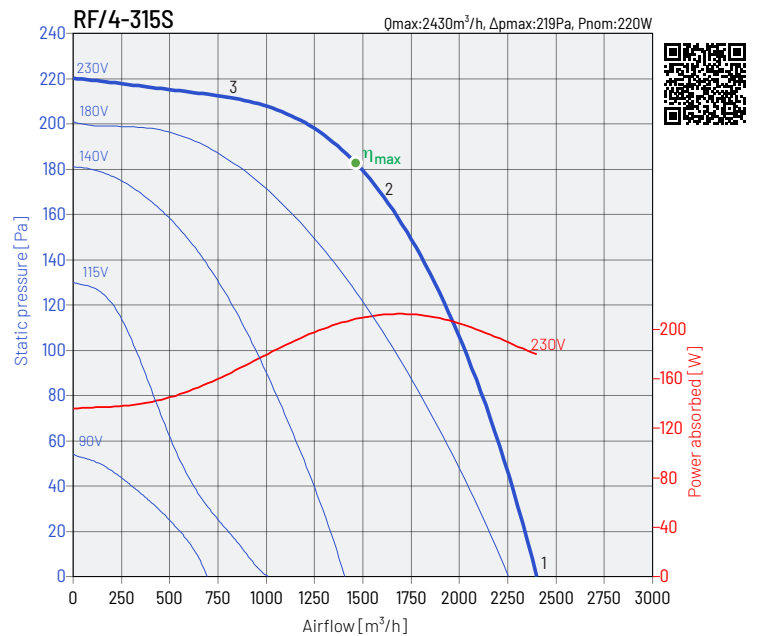

working point	63 Hz	125 Hz	250 Hz	500 Hz	1000 Hz	2000 Hz	4000 Hz	8000 Hz	L_{WA}
1	inlet								
	outlet	52	58	61	65	62	58	48	69
2	inlet								
	outlet	50	56	59	63	60	54	44	67
3	inlet								
	outlet	48	54	58	61	58	51	42	65

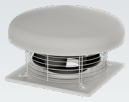

PERFORMANCE CHARACTERISTICS OF THE FANS

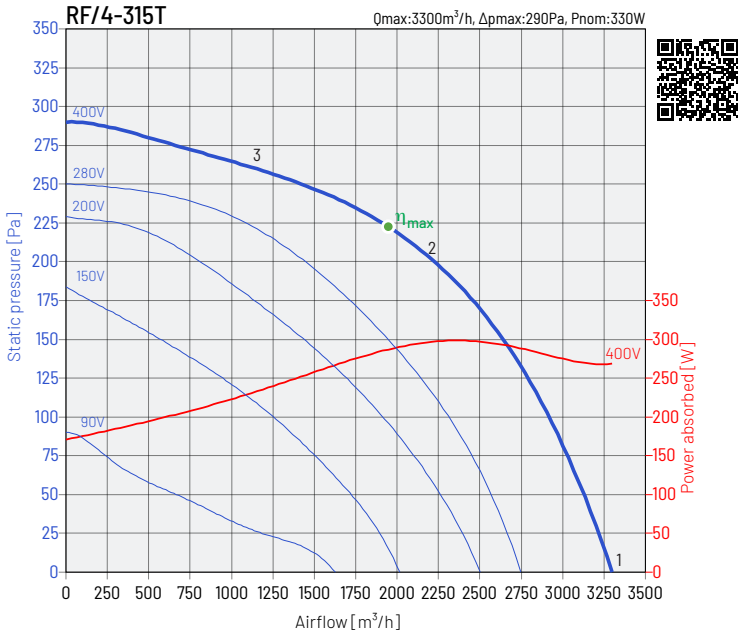

working point	63 Hz	125 Hz	250 Hz	500 Hz	1000 Hz	2000 Hz	4000 Hz	8000 Hz	L_{wa}
1	inlet								
	outlet	54	60	64	67	63	57	47	71
2	inlet								
	outlet	52	58	63	66	62	55	45	69
3	inlet								
	outlet	50	56	61	64	60	52	42	67

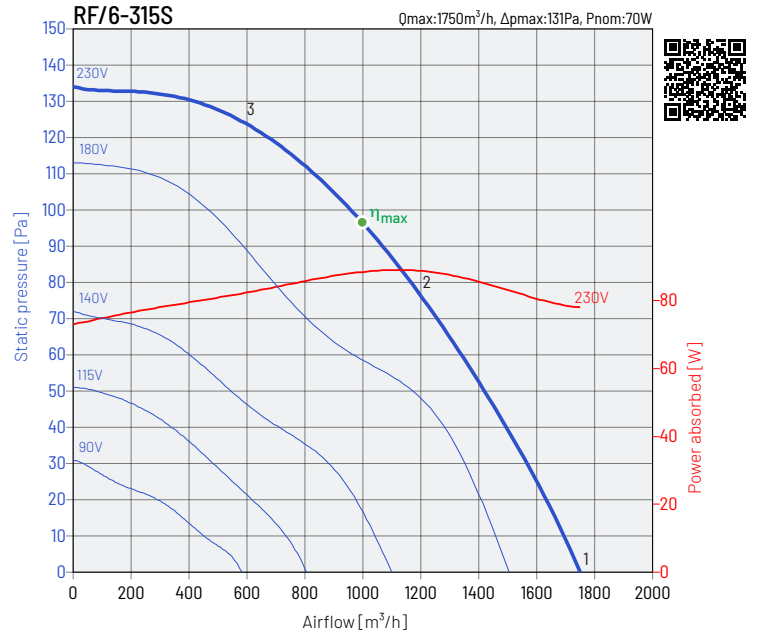

working point	63 Hz	125 Hz	250 Hz	500 Hz	1000 Hz	2000 Hz	4000 Hz	8000 Hz	L_{wa}
1	inlet								
	outlet	44	48	53	53	50	41	25	58
2	inlet								
	outlet	40	46	52	52	49	42	26	57
3	inlet								
	outlet	41	46	51	53	48	39	25	57

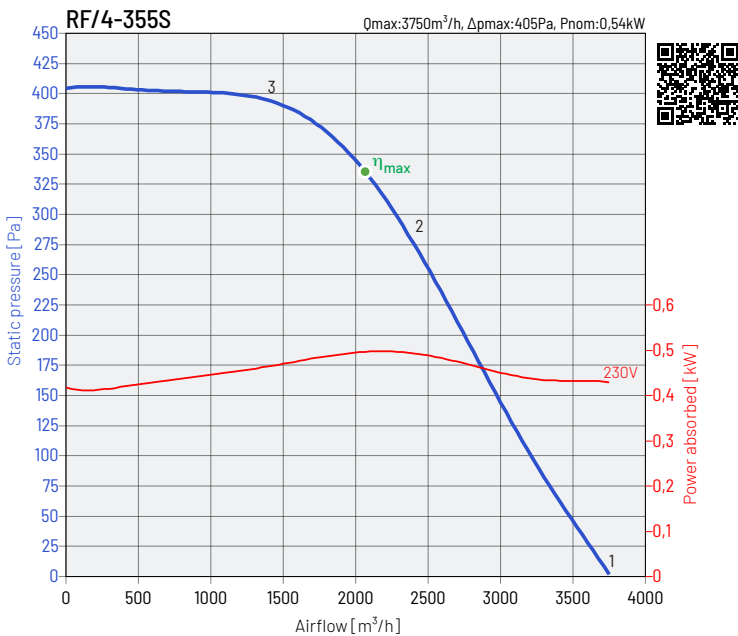

working point	63 Hz	125 Hz	250 Hz	500 Hz	1000 Hz	2000 Hz	4000 Hz	8000 Hz	L_{wa}
1	inlet	44	63	67	72	69	67	78	80
	outlet	50	62	66	71	72	68	66	76
2	inlet	45	60	64	69	66	64	74	77
	outlet	52	60	64	69	70	67	62	75
3	inlet	42	55	60	63	62	62	68	72
	outlet	50	58	62	67	67	64	59	72

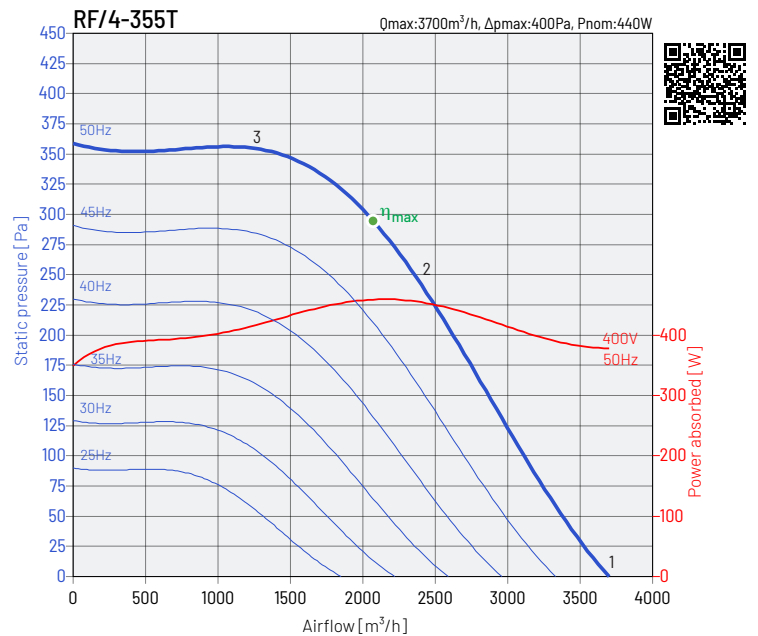

working point	63 Hz	125 Hz	250 Hz	500 Hz	1000 Hz	2000 Hz	4000 Hz	8000 Hz	L_{wa}
1	inlet	44	63	67	72	69	67	78	80
	outlet	50	62	66	70	70	67	66	75
2	inlet	45	60	64	69	66	64	74	77
	outlet	52	59	64	69	69	65	60	74
3	inlet	42	55	60	63	62	62	68	72
	outlet	50	58	62	67	67	64	59	72

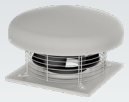

PERFORMANCE CHARACTERISTICS OF THE FANS

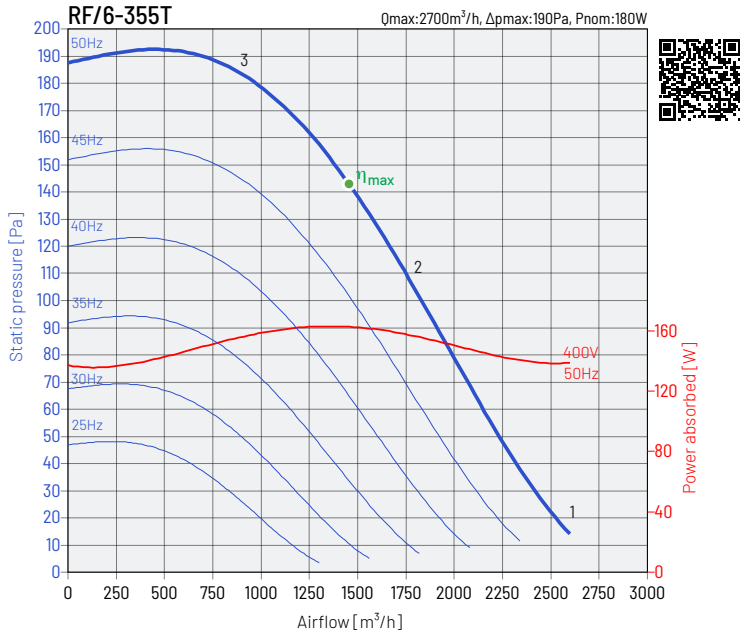

working point		63 Hz	125 Hz	250 Hz	500 Hz	1000 Hz	2000 Hz	4000 Hz	8000 Hz	L_{WA}
1	inlet	35	54	58	63	60	58	69	62	71
	outlet	49	54	57	61	62	62	57	39	68
2	inlet	37	52	56	61	58	56	66	58	69
	outlet	44	49	55	58	59	56	52	38	64
3	inlet	34	47	52	55	54	54	60	55	64
	outlet	40	44	48	55	52	49	44	35	58

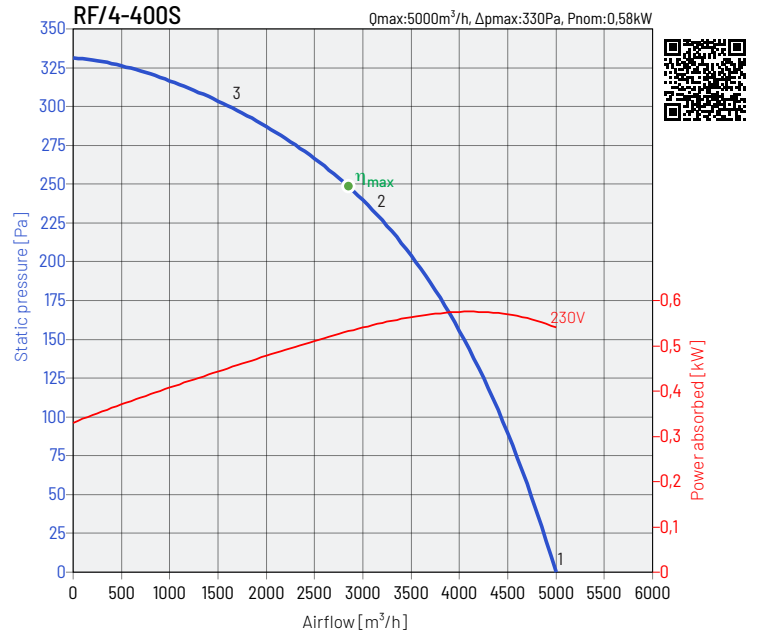

working point		63 Hz	125 Hz	250 Hz	500 Hz	1000 Hz	2000 Hz	4000 Hz	8000 Hz	L_{WA}
1	inlet	46	62	68	73	71	75	89	67	89
	outlet	56	67	74	78	80	76	72	60	84
2	inlet	47	62	67	70	66	68	69	53	75
	outlet	53	64	70	73	75	71	68	58	79
3	inlet	49	60	64	68	65	66	60	54	73
	outlet	50	61	67	69	72	67	60	50	76

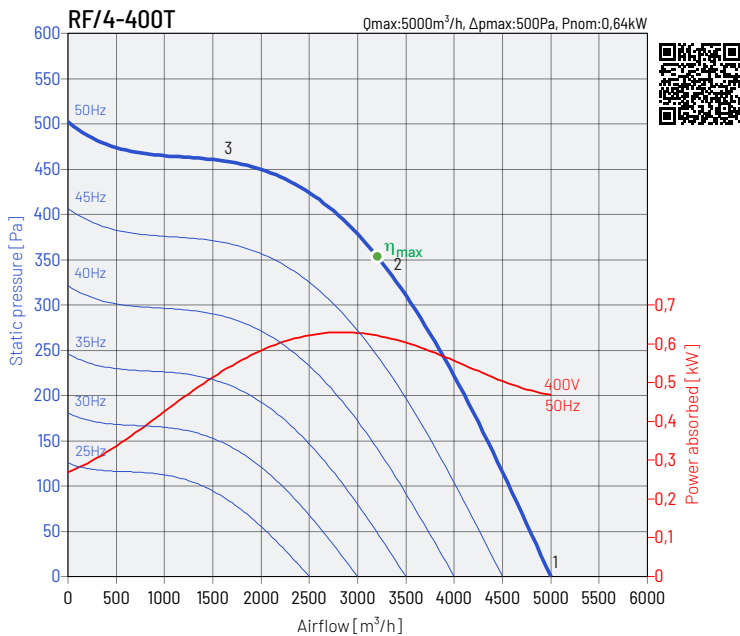

working point		63 Hz	125 Hz	250 Hz	500 Hz	1000 Hz	2000 Hz	4000 Hz	8000 Hz	L_{WA}
1	inlet	46	62	68	73	71	75	89	67	89
	outlet	56	67	75	79	81	77	73	60	85
2	inlet	47	62	67	70	66	68	69	53	75
	outlet	53	64	71	74	76	72	68	58	80
3	inlet	49	60	64	68	65	66	60	54	73
	outlet	51	61	67	70	73	68	61	51	76

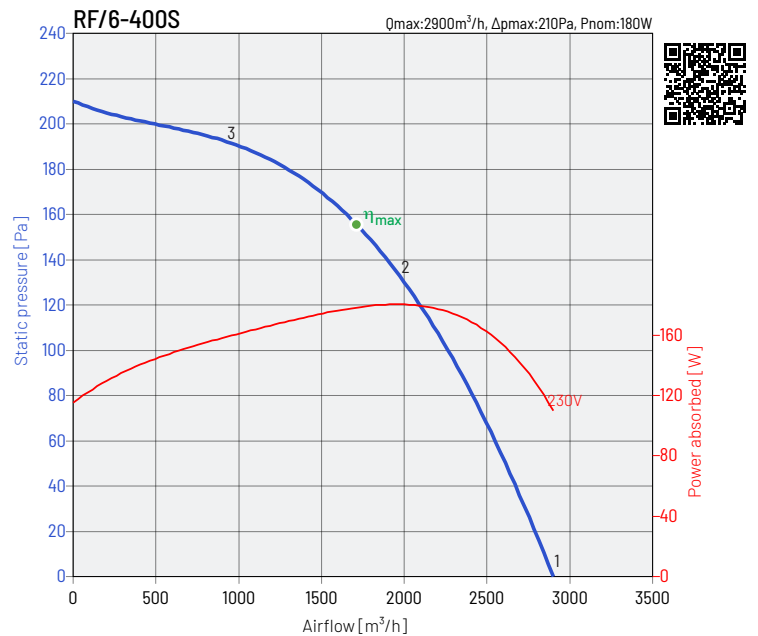

working point		63 Hz	125 Hz	250 Hz	500 Hz	1000 Hz	2000 Hz	4000 Hz	8000 Hz	L_{WA}
1	inlet	32	51	58	62	59	65	61	47	69
	outlet	46	59	64	65	69	67	63	50	73
2	inlet	27	45	51	56	53	55	52	42	61
	outlet	45	57	61	63	66	62	58	45	70
3	inlet	24	44	45	50	50	51	47	41	56
	outlet	44	54	58	62	62	57	51	40	67

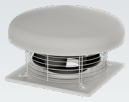

PERFORMANCE CHARACTERISTICS OF THE FANS

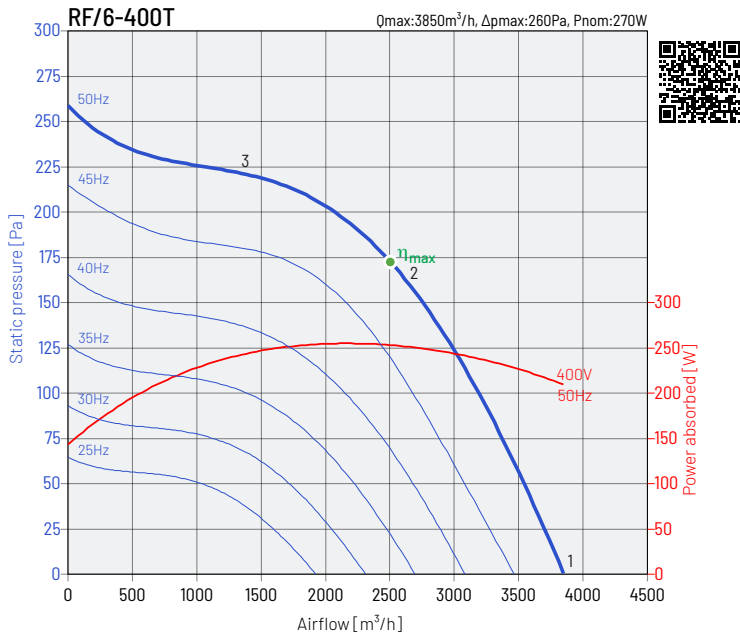

working point		63 Hz	125 Hz	250 Hz	500 Hz	1000 Hz	2000 Hz	4000 Hz	8000 Hz	L_{wa}
1	inlet	40	55	63	66	65	75	65	50	76
	outlet	56	57	63	68	70	67	57	41	74
2	inlet	37	49	55	58	56	62	51	40	65
	outlet	51	56	61	66	67	65	55	40	72
3	inlet	46	52	57	59	56	53	46	40	63
	outlet	47	53	58	64	66	60	50	39	69

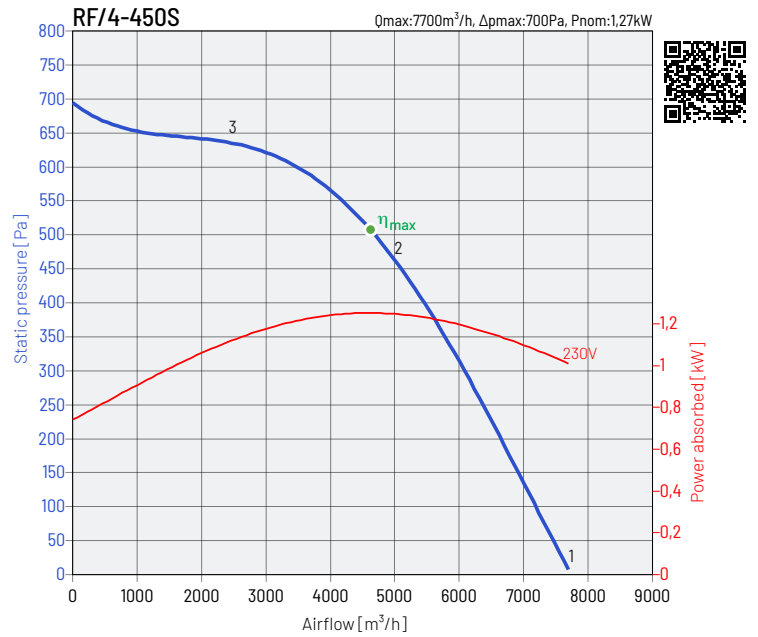

working point		63 Hz	125 Hz	250 Hz	500 Hz	1000 Hz	2000 Hz	4000 Hz	8000 Hz	L_{wa}
1	inlet	53	72	78	81	80	77	73	63	86
	outlet	56	67	76	82	84	79	77	65	88
2	inlet	52	68	74	77	75	72	64	58	81
	outlet	52	65	73	78	80	76	73	62	84
3	inlet	49	62	69	70	69	68	60	56	75
	outlet	50	62	70	74	77	73	70	60	81

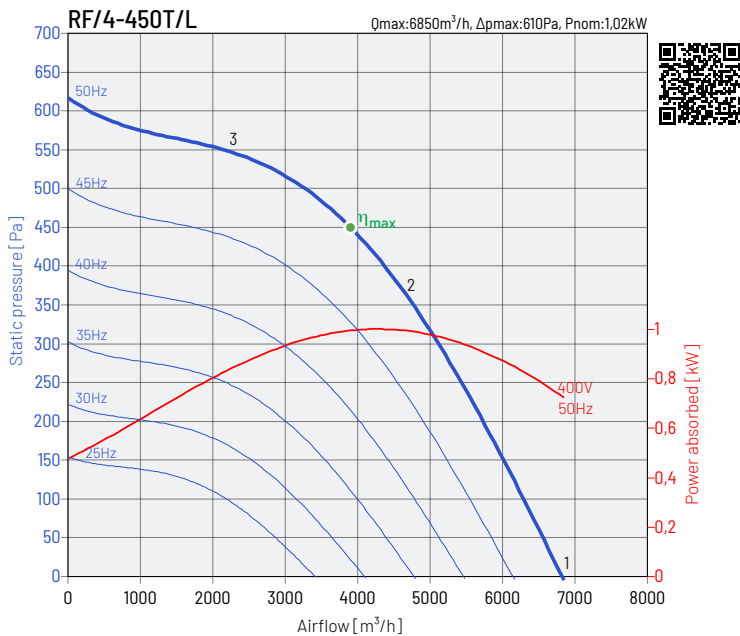

working point		63 Hz	125 Hz	250 Hz	500 Hz	1000 Hz	2000 Hz	4000 Hz	8000 Hz	L_{wa}
1	inlet	47	66	72	74	72	76	68	60	80
	outlet	54	63	74	80	82	79	72	63	86
2	inlet	41	60	62	64	65	69	62	53	73
	outlet	50	60	70	79	79	76	70	62	83
3	inlet	54	67	68	68	67	66	59	52	74
	outlet	47	57	67	74	76	71	68	60	80

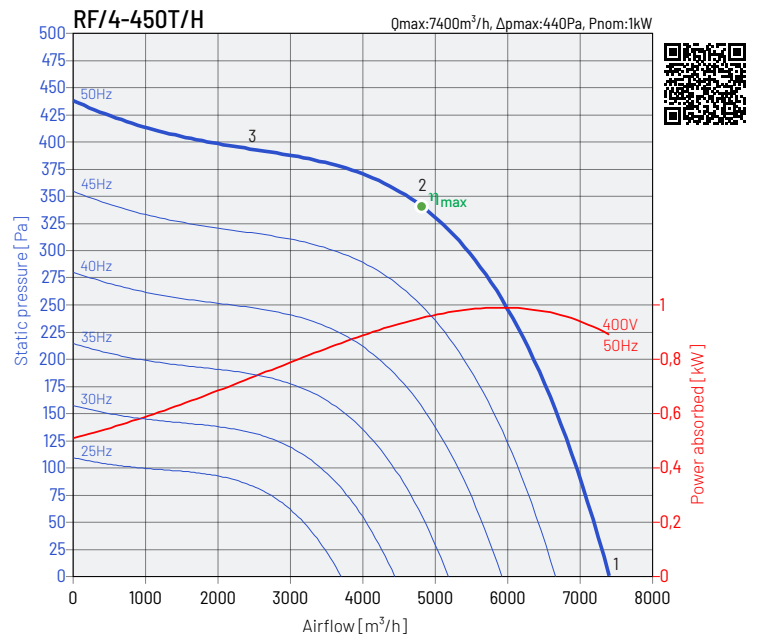

working point		63 Hz	125 Hz	250 Hz	500 Hz	1000 Hz	2000 Hz	4000 Hz	8000 Hz	L_{wa}
1	inlet	43	60	64	67	68	70	70	63	76
	outlet	56	65	76	82	85	81	73	64	88
2	inlet	37	58	62	65	67	68	68	61	74
	outlet	53	63	72	80	82	78	70	62	85
3	inlet	34	56	60	63	65	66	63	56	71
	outlet	52	60	68	78	79	73	68	61	82

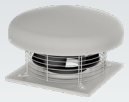

PERFORMANCE CHARACTERISTICS OF THE FANS

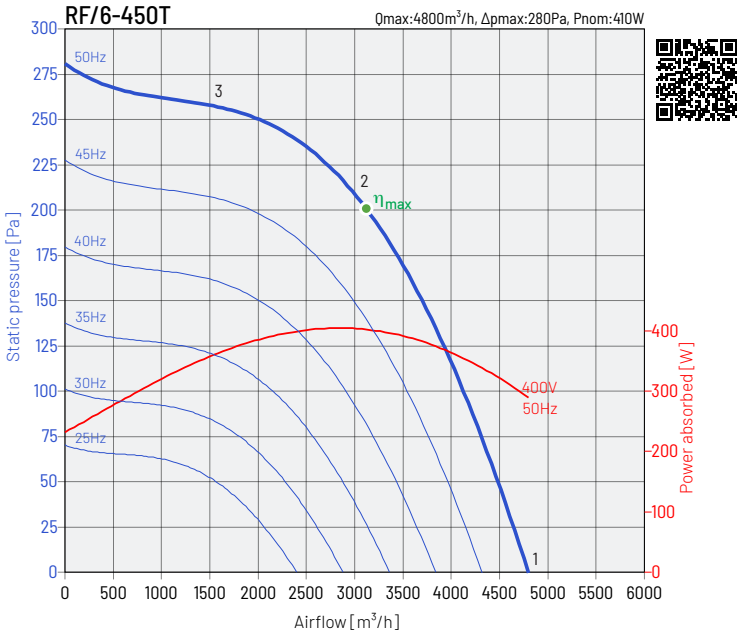

working point		63 Hz	125 Hz	250 Hz	500 Hz	1000 Hz	2000 Hz	4000 Hz	8000 Hz	L_{WA}
1	inlet	44	63	69	72	71	68	64	54	77
	outlet	58	66	70	74	75	72	72	54	80
2	inlet	43	59	65	68	66	63	55	49	72
	outlet	55	64	68	72	72	69	65	51	77
3	inlet	39	52	59	60	59	58	50	46	65
	outlet	50	60	63	67	70	66	60	50	74

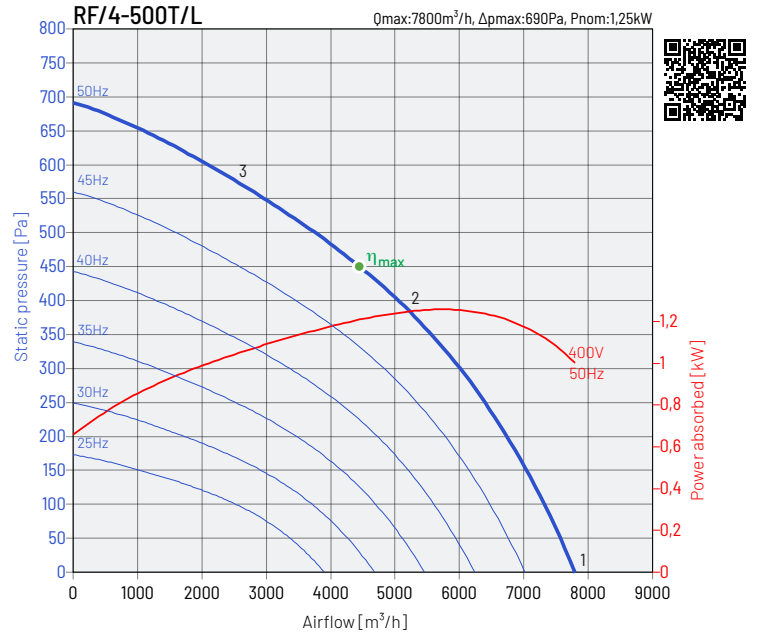

working point		63 Hz	125 Hz	250 Hz	500 Hz	1000 Hz	2000 Hz	4000 Hz	8000 Hz	L_{WA}
1	inlet	49	68	70	70	71	70	70	65	78
	outlet	60	72	78	83	87	81	77	65	90
2	inlet	46	65	67	68	67	65	66	62	75
	outlet	55	68	72	79	83	77	74	61	86
3	inlet	44	62	62	66	64	60	59	58	71
	outlet	52	64	68	74	80	75	72	58	83

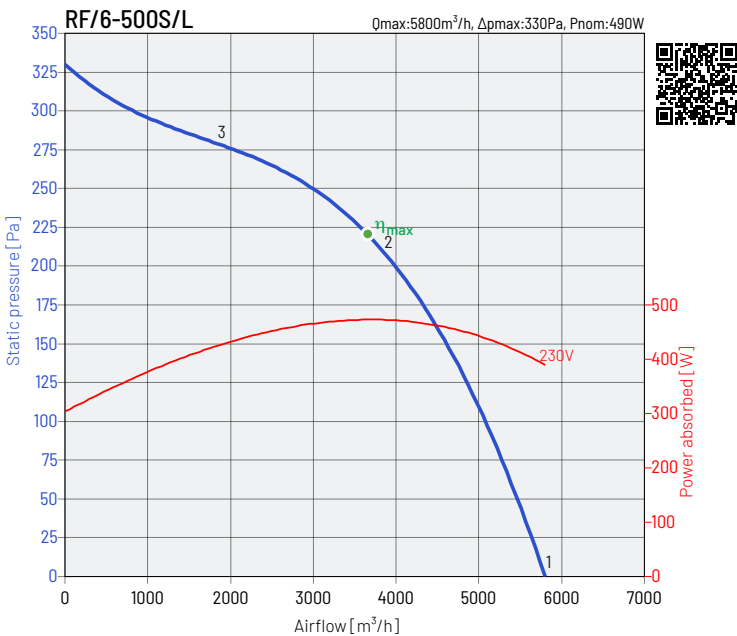

working point		63 Hz	125 Hz	250 Hz	500 Hz	1000 Hz	2000 Hz	4000 Hz	8000 Hz	L_{WA}
1	inlet	43	60	67	70	69	73	72	70	78
	outlet	58	69	72	76	83	79	74	64	86
2	inlet	39	55	62	65	64	65	65	57	72
	outlet	55	67	73	74	81	77	72	62	84
3	inlet	34	54	57	59	62	64	61	54	69
	outlet	53	64	67	69	73	69	65	57	77

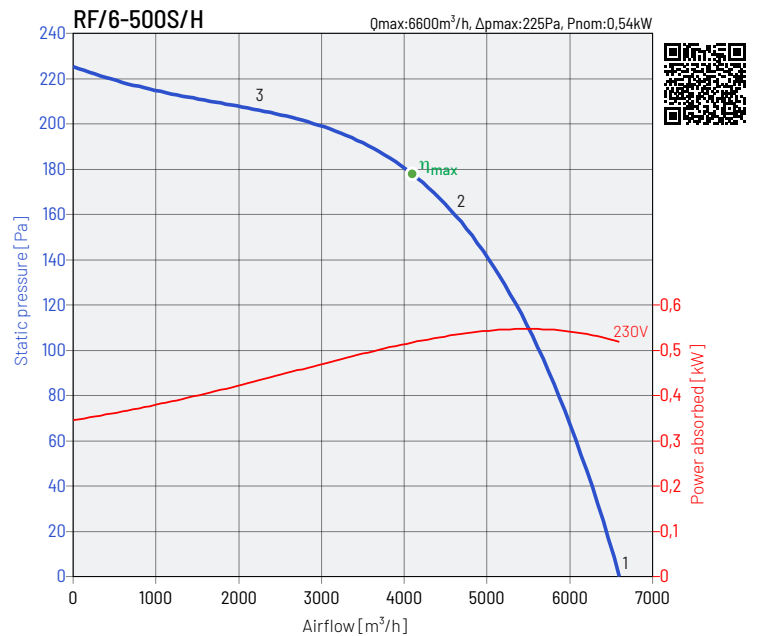

working point		63 Hz	125 Hz	250 Hz	500 Hz	1000 Hz	2000 Hz	4000 Hz	8000 Hz	L_{WA}
1	inlet	58	66	63	65	66	64	58	72	75
	outlet	54	65	68	72	77	74	70	60	80
2	inlet	55	65	61	63	63	61	54	70	73
	outlet	53	63	65	68	74	70	68	59	77
3	inlet	55	65	59	61	62	57	48	69	72
	outlet	52	62	64	67	72	68	66	57	76

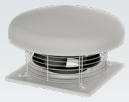

PERFORMANCE CHARACTERISTICS OF THE FANS

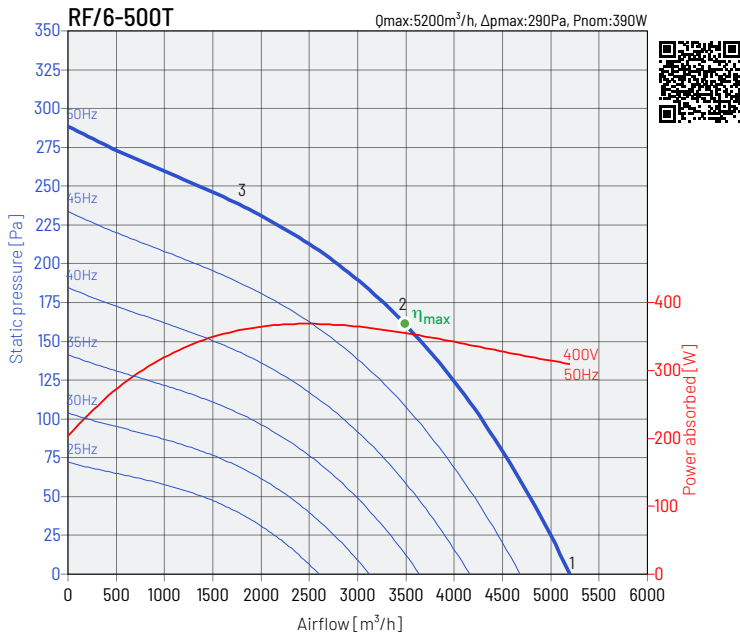

working point		63 Hz	125 Hz	250 Hz	500 Hz	1000 Hz	2000 Hz	4000 Hz	8000 Hz	L_{wa}
1	inlet	47	55	60	63	64	61	56	68	71
	outlet	54	66	72	77	80	75	72	59	83
2	inlet	43	53	57	62	63	57	51	63	68
	outlet	52	61	67	71	73	68	67	54	77
3	inlet	41	49	55	60	60	55	50	55	65
	outlet	51	59	65	69	71	67	66	52	75

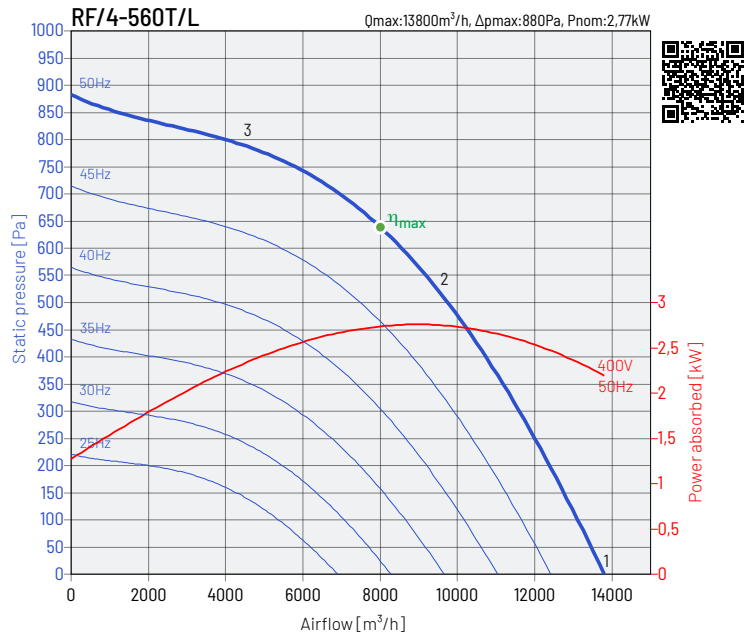

working point		63 Hz	125 Hz	250 Hz	500 Hz	1000 Hz	2000 Hz	4000 Hz	8000 Hz	L_{wa}
1	inlet	50	67	69	72	73	73	73	69	80
	outlet	56	70	76	83	85	81	75	61	89
2	inlet	43	60	67	69	71	71	70	66	77
	outlet	54	68	75	79	83	80	74	57	86
3	inlet	43	60	64	68	69	69	67	61	75
	outlet	52	66	72	77	81	79	73	55	85

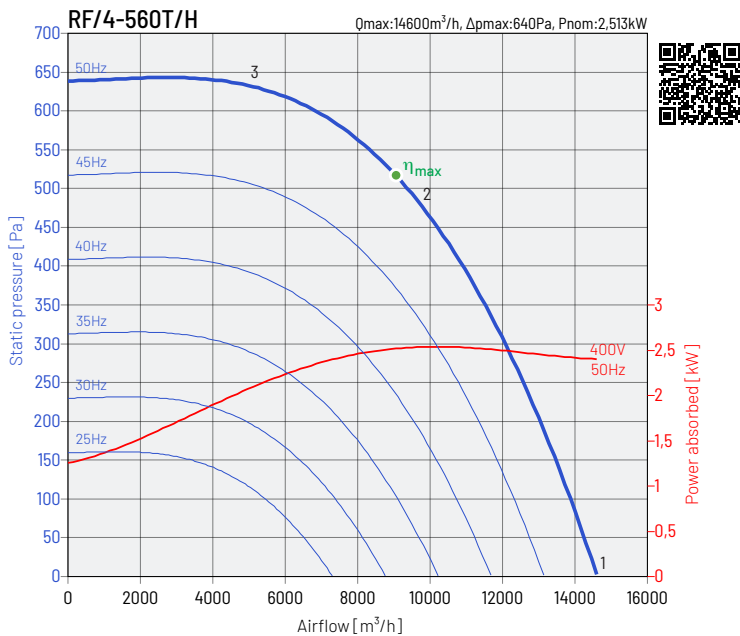

working point		63 Hz	125 Hz	250 Hz	500 Hz	1000 Hz	2000 Hz	4000 Hz	8000 Hz	L_{wa}
1	inlet	50	67	70	73	74	74	74	70	81
	outlet	57	71	78	83	86	83	77	63	90
2	inlet	43	61	68	70	72	71	70	66	78
	outlet	55	69	75	79	84	80	74	60	87
3	inlet	43	60	64	68	70	70	67	61	76
	outlet	53	67	73	77	82	79	73	59	85

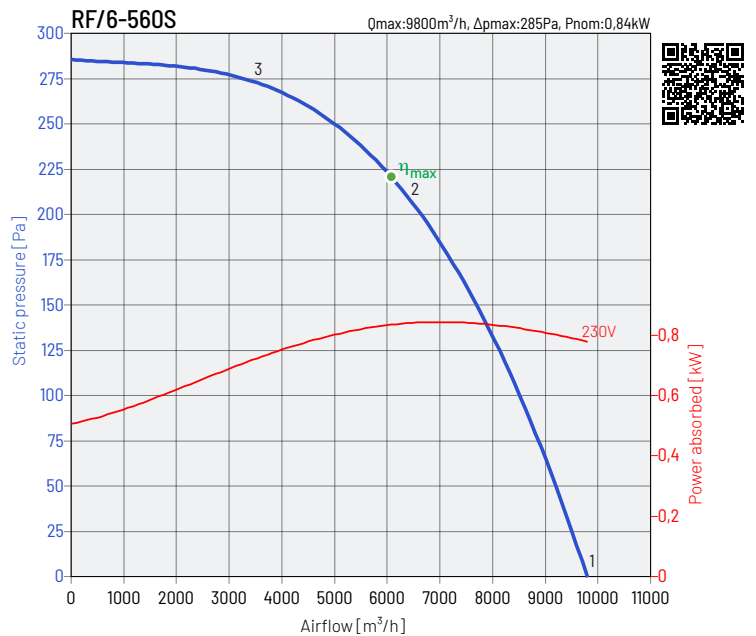

working point		63 Hz	125 Hz	250 Hz	500 Hz	1000 Hz	2000 Hz	4000 Hz	8000 Hz	L_{wa}
1	inlet	47	62	64	66	67	67	65	61	74
	outlet	52	64	71	72	75	72	69	55	79
2	inlet	38	58	61	63	64	63	60	54	70
	outlet	50	61	68	69	72	69	67	53	76
3	inlet	42	57	60	62	63	62	58	51	69
	outlet	49	61	67	68	70	68	67	52	75

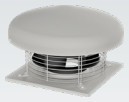

PERFORMANCE CHARACTERISTICS OF THE FANS

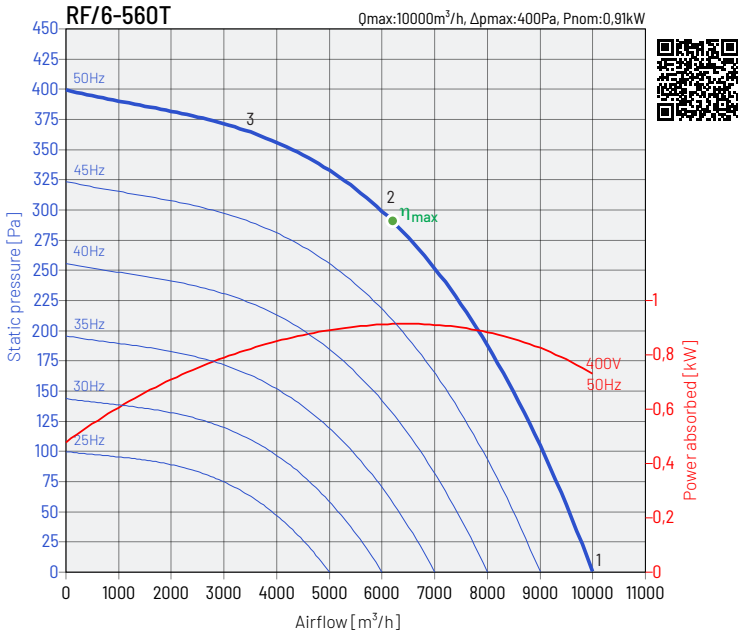

working point		63 Hz	125 Hz	250 Hz	500 Hz	1000 Hz	2000 Hz	4000 Hz	8000 Hz	L_{WA}
1	inlet	45	64	70	70	71	77	85	66	86
	outlet	54	66	72	74	79	76	69	58	82
2	inlet	40	61	64	64	65	72	81	62	82
	outlet	52	64	69	71	76	73	67	56	79
3	inlet	37	54	57	58	64	61	54	49	67
	outlet	50	61	66	70	75	69	62	52	78

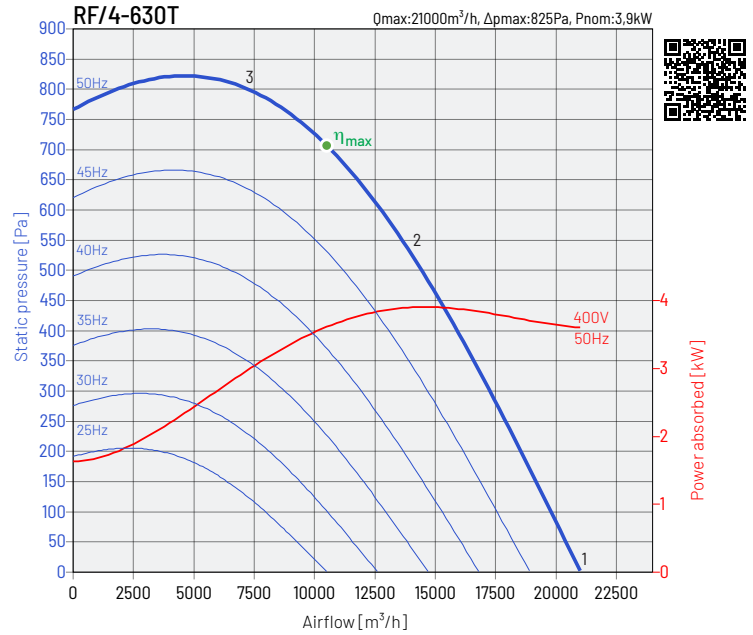

working point		63 Hz	125 Hz	250 Hz	500 Hz	1000 Hz	2000 Hz	4000 Hz	8000 Hz	L_{WA}
1	inlet	61	72	77	76	80	77	67	62	84
	outlet	63	75	78	82	84	80	69	64	88
2	inlet	57	66	72	72	75	71	63	57	79
	outlet	60	71	75	78	80	75	68	60	84
3	inlet	59	68	74	75	78	73	67	60	82
	outlet	62	71	78	79	82	77	71	63	86

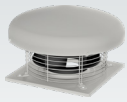

ECO PROJECT

Type	RF/4-125S	RF/4-125S*
a Supplier name	VENTURE INDUSTRIES	VENTURE INDUSTRIES
b Article number	43528015	43528015
c SEC average	-17,14	-28,30
c SEC cold	-33,55	-55,36
c SEC warm	-7,75	-12,79
c SEC class	E	B
d Device category	NRVU	NRVU
d Device type	UVU	UVU
e Type of drive	variable speed drive v	variable speed drive v
f Type of heat recovery system	not applicable	not applicable
g Thermal efficiency of heat recovery [%]	not applicable	not applicable
h Maximum flow rate [m ³ /h]	169	169
i Electric power input [W]	39	39
j Sound power level L _{wa} [dB(A)]	54	54
k Reference flow rate [m ³ /s]	0,03	0,03
l Reference pressure difference [Pa]	50	50
m SPI [kW/(m ² /h)]	0,000230769	0,000230769
n CRS/CTRL	1	1
o Maximum external leakage rate [%]	0	0
p Mixing rate	not applicable	not applicable
q Position of visual filter warning	not applicable	not applicable
r Instructions to install supply grilles	not applicable	not applicable
s Internet address	www.ventur.eu	www.ventur.eu
t Airflow sensitivity to pressure variation	not applicable	not applicable
u Indoor/outdoor air tightness	not applicable	not applicable
v Annual electricity consumption - average climate [kWh/a]	289	122
v Annual electricity consumption - cold climate [kWh/a]	289	122
v Annual electricity consumption - warm climate [kWh/a]	289	122
w Annual heating saved - average climate [kWh/a]	3355	5536
w Annual heating saved - cold climate [kWh/a]	1715	2830
w Annual heating saved - warm climate [kWh/a]	776	1280
MISC	1,1	1,1
CRS	1	0,65
x-value	1	2

* Device with local control according to demand.

Type	RF/2-125S	RF/2-160S	RF/2-160S/H	RF/4-160S	RF/4-160S/L
a Supplier name	VENTURE INDUSTRIES	VENTURE INDUSTRIES	VENTURE INDUSTRIES	VENTURE INDUSTRIES	VENTURE INDUSTRIES
b Article number	43528010	43528031	43528033	43528036	43528036
c Device category	NRVU	NRVU	NRVU	NRVU	NRVU
c Device type	UVU	UVU	UVU	UVU	UVU
d Type of drive	variable speed drive v	variable speed drive v	variable speed drive v	variable speed drive v	variable speed drive v
e Type of heat recovery system	not applicable	not applicable	not applicable	not applicable	not applicable
f Thermal efficiency of heat recovery [%]	not applicable	not applicable	not applicable	not applicable	not applicable
g Reference flow rate in NRVU [m ³ /s]	0,07	0,14	0,22	0,11	0,07
h Electric power input [kW]	0,049	0,101	0,153	0,038	0,032
i SFPint [W/(m ² /s)]	705,60	737,53	711,63	348,98	315,6
j Face velocity [m/s]	0,47	0,77	1,22	0,62	0,59
k Δps, ext [Pa]	225	243	300	87	92
l Δps, int [Pa]	not applicable	not applicable	not applicable	not applicable	not applicable
m Δps, add [Pa]	not applicable	not applicable	not applicable	not applicable	not applicable
n Static efficiency of fans [%]	32,03%	32,80%	42,20%	24,80%	20,60%
o Maximum external leakage rate [%]	0	0	0	0	0
p Energy performance	not applicable	not applicable	not applicable	not applicable	not applicable
q Visual filter warning	not applicable	not applicable	not applicable	not applicable	not applicable
r L _{wa} [dB(A)]	72	75	76	61	62
s Internet address	www.ventur.eu	www.ventur.eu	www.ventur.eu	www.ventur.eu	www.ventur.eu

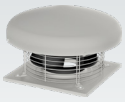

ECO PROJECT

Type	RF/2-200S	RF/4-200S	RF/4-250S	RF/4-250T	RF/6-250S
a Supplier name	VENTURE INDUSTRIES	VENTURE INDUSTRIES	VENTURE INDUSTRIES	VENTURE INDUSTRIES	VENTURE INDUSTRIES
b Article number	43528040	43528050	43528060	43522080	43528100
c Device category	NRVU	NRVU	NRVU	NRVU	NRVU
d Device type	UVU	UVU	UVU	UVU	UVU
e Type of drive	variable speed drive v	variable speed drive v	variable speed drive v	variable speed drive v	variable speed drive v
f Type of heat recovery system	not applicable	not applicable	not applicable	not applicable	not applicable
g Thermal efficiency of heat recovery [%]	not applicable	not applicable	not applicable	not applicable	not applicable
h Reference flow rate in NRVU [m³/s]	0,26	0,20	0,26	0,25	0,17
i Electric power input [kW]	0,26	0,099	0,115	0,136	0,047
j SFPint [W/(m²/s)]	987,34	504,82	440,89	554,47	276,47
k Face velocity [m/s]	1,20	0,89	1,14	1,07	0,74
l Δps, ext [Pa]	359	147	134	176	75
m Δps, int [Pa]	not applicable	not applicable	not applicable	not applicable	not applicable
n Δps, add [Pa]	not applicable	not applicable	not applicable	not applicable	not applicable
o Static efficiency of fans [%]	36,29%	29,20%	30,22%	31,64%	27,00%
p Maximum external leakage rate [%]	0	0	0	0	0
q Energy performance	not applicable	not applicable	not applicable	not applicable	not applicable
r Visual filter warning	not applicable	not applicable	not applicable	not applicable	not applicable
s L _{WA} [dB(A)]	75	64	62	63	53
t Internet address	www.ventur.eu	www.ventur.eu	www.ventur.eu	www.ventur.eu	www.ventur.eu

Type	RF/4-315S	RF/4-315T	RF/6-315S	RF/4-355S	RF/4-355T
a Supplier name	VENTURE INDUSTRIES	VENTURE INDUSTRIES	VENTURE INDUSTRIES	VENTURE INDUSTRIES	VENTURE INDUSTRIES
b Article number	43528070	43528090	43528110	43528120	43528125
c Device category	NRVU	NRVU	NRVU	NRVU	NRVU
d Device type	UVU	UVU	UVU	UVU	UVU
e Type of drive	variable speed drive v	variable speed drive v	variable speed drive v	variable speed drive v	variable speed drive v
f Type of heat recovery system	not applicable	not applicable	not applicable	not applicable	not applicable
g Thermal efficiency of heat recovery [%]	not applicable	not applicable	not applicable	not applicable	not applicable
h Reference flow rate in NRVU [m³/s]	0,42	0,61	0,28	0,53	0,55
i Electric power input [kW]	0,208	0,29	0,09	0,49	0,46
j SFPint [W/(m²/s)]	492,31	475,41	325,30	925	829
k Face velocity [m/s]	1,65	2,38	1,08	1,68	1,74
l Δps, ext [Pa]	183	201	98	353	341
m Δps, int [Pa]	not applicable	not applicable	not applicable	not applicable	not applicable
n Δps, add [Pa]	not applicable	not applicable	not applicable	not applicable	not applicable
o Static efficiency of fans [%]	37,06%	42,40%	29,10%	38,2	41,1
p Maximum external leakage rate [%]	0	0	0	0	0
q Energy performance	not applicable	not applicable	not applicable	not applicable	not applicable
r Visual filter warning	not applicable	not applicable	not applicable	not applicable	not applicable
s L _{WA} [dB(A)]	67	69	56	70	68
t Internet address	www.ventur.eu	www.ventur.eu	www.ventur.eu	www.ventur.eu	www.ventur.eu

Type	RF/6-355T	RF/4-400S	RF/4-400T	RF/6-400S	RF/6-400T
a Supplier name	VENTURE INDUSTRIES	VENTURE INDUSTRIES	VENTURE INDUSTRIES	VENTURE INDUSTRIES	VENTURE INDUSTRIES
b Article number	43528135	43528140	43528142	43528145	43528146
c Device category	NRVU	NRVU	NRVU	NRVU	NRVU
d Device type	UVU	UVU	UVU	UVU	UVU
e Type of drive	variable speed drive v	variable speed drive v	variable speed drive v	variable speed drive v	variable speed drive v
f Type of heat recovery system	not applicable	not applicable	not applicable	not applicable	not applicable
g Thermal efficiency of heat recovery [%]	not applicable	not applicable	not applicable	not applicable	not applicable
h Reference flow rate in NRVU [m³/s]	0,44	0,78	0,85	0,43	0,84
i Electric power input [kW]	0,16	0,52	0,64	0,18	0,24
j SFPint [W/(m²/s)]	376	669	755	411	289
k Face velocity [m/s]	1,37	2,2	2,41	1,22	2,38
l Δps, ext [Pa]	133	261	382	167	125
m Δps, int [Pa]	not applicable	not applicable	not applicable	not applicable	not applicable
n Δps, add [Pa]	not applicable	not applicable	not applicable	not applicable	not applicable
o Static efficiency of fans [%]	35,4	38,8	49,5	40,6	43,4
p Maximum external leakage rate [%]	0	0	0	0	0
q Energy performance	not applicable	not applicable	not applicable	not applicable	not applicable
r Visual filter warning	not applicable	not applicable	not applicable	not applicable	not applicable
s L _{WA} [dB(A)]	59	71	73	63	63
t Internet address	www.ventur.eu	www.ventur.eu	www.ventur.eu	www.ventur.eu	www.ventur.eu

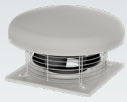

ECO PROJECT

Type	RF/4-450S	RF/4-450T/L	RF/4-450T/H	RF/6-450T	RF/4-500T/L
a Supplier name	VENTURE INDUSTRIES	VENTURE INDUSTRIES	VENTURE INDUSTRIES	VENTURE INDUSTRIES	VENTURE INDUSTRIES
b Article number	43528150	43528151	43528152	43528155	43528161
c Device category	NRVU	NRVU	NRVU	NRVU	NRVU
d Device type	UVU	UVU	UVU	UVU	UVU
e Type of drive	variable speed drive v	variable speed drive v	variable speed drive v	variable speed drive v	variable speed drive v
f Type of heat recovery system	not applicable	not applicable	not applicable	not applicable	not applicable
g Thermal efficiency of heat recovery [%]	not applicable	not applicable	not applicable	not applicable	not applicable
h Reference flow rate in NRVU [m³/s]	1,14	1,26	1,37	0,83	1,33
i Electric power input [kW]	1,27	0,99	0,96	0,41	1,22
j SFPint [W/(m²/s)]	1115	785	699	492	915
k Face velocity [m/s]	2,9	3,21	3,48	2,12	3,03
l Δps, ext [Pa]	548	385	336	211	434
m Δps, int [Pa]	not applicable	not applicable	not applicable	not applicable	not applicable
n Δps, add [Pa]	not applicable	not applicable	not applicable	not applicable	not applicable
o Static efficiency of fans [%]	49,9	49,0	48,0	42,9	47,4
p Maximum external leakage rate [%]	0	0	0	0	0
q Energy performance	not applicable	not applicable	not applicable	not applicable	not applicable
r Visual filter warning	not applicable	not applicable	not applicable	not applicable	not applicable
s L _{WA} [dB(A)]	72	77	78	64	72
t Internet address	www.ventur.eu	www.ventur.eu	www.ventur.eu	www.ventur.eu	www.ventur.eu

Type	RF/6-500S/L	RF/6-500S/H	RF/6-500T	RF/4-560T/L	RF/4-560T/H
a Supplier name	VENTURE INDUSTRIES	VENTURE INDUSTRIES	VENTURE INDUSTRIES	VENTURE INDUSTRIES	VENTURE INDUSTRIES
b Article number	43528162	43528165	43528164	43528170	43528172
c Device category	NRVU	NRVU	NRVU	NRVU	NRVU
d Device type	UVU	UVU	UVU	UVU	UVU
e Type of drive	variable speed drive v	variable speed drive v	variable speed drive v	variable speed drive v	variable speed drive v
f Type of heat recovery system	not applicable	not applicable	not applicable	not applicable	not applicable
g Thermal efficiency of heat recovery [%]	not applicable	not applicable	not applicable	not applicable	not applicable
h Reference flow rate in NRVU [m³/s]	1,08	1,1	0,99	2,34	2,36
i Electric power input [kW]	0,47	0,52	0,35	2,73	2,51
j SFPint [W/(m²/s)]	435	469	352	1167	1063
k Face velocity [m/s]	2,46	2,49	2,25	4,73	4,77
l Δps, ext [Pa]	205	182	152	604	510
m Δps, int [Pa]	not applicable	not applicable	not applicable	not applicable	not applicable
n Δps, add [Pa]	not applicable	not applicable	not applicable	not applicable	not applicable
o Static efficiency of fans [%]	47,2	38,8	43,2	51,8	47,9
p Maximum external leakage rate [%]	0	0	0	0	0
q Energy performance	not applicable	not applicable	not applicable	not applicable	not applicable
r Visual filter warning	not applicable	not applicable	not applicable	not applicable	not applicable
s L _{WA} [dB(A)]	68	66	66	76	77
t Internet address	www.ventur.eu	www.ventur.eu	www.ventur.eu	www.ventur.eu	www.ventur.eu

Type	RF/6-560S	RF/6-560T	RF/4-630T
a Supplier name	VENTURE INDUSTRIES	VENTURE INDUSTRIES	VENTURE INDUSTRIES
b Article number	43528174	43528176	43528185
c Device category	NRVU	NRVU	NRVU
d Device type	UVU	UVU	UVU
e Type of drive	variable speed drive v	variable speed drive v	variable speed drive v
f Type of heat recovery system	not applicable	not applicable	not applicable
g Thermal efficiency of heat recovery [%]	not applicable	not applicable	not applicable
h Reference flow rate in NRVU [m³/s]	1,66	1,92	3,24
i Electric power input [kW]	0,82	0,91	3,77
j SFPint [W/(m²/s)]	495	475	1163
k Face velocity [m/s]	3,35	3,87	5,8
l Δps, ext [Pa]	218	259	663
m Δps, int [Pa]	not applicable	not applicable	not applicable
n Δps, add [Pa]	not applicable	not applicable	not applicable
o Static efficiency of fans [%]	44,0	54,6	57,0
p Maximum external leakage rate [%]	0	0	0
q Energy performance	not applicable	not applicable	not applicable
r Visual filter warning	not applicable	not applicable	not applicable
s L _{WA} [dB(A)]	66	69	79
t Internet address	www.ventur.eu	www.ventur.eu	www.ventur.eu

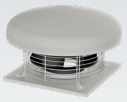

DIMENSIONS

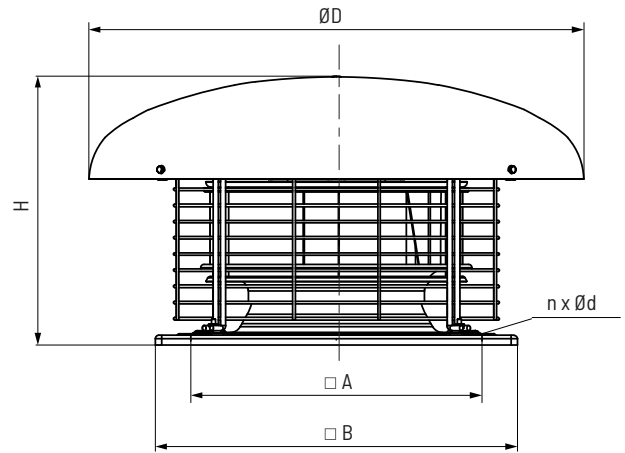
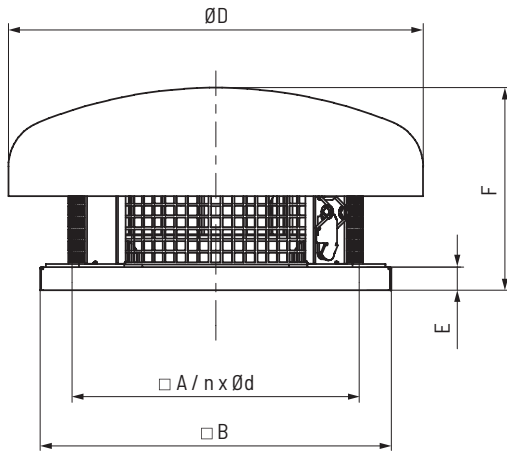

type	A mm	B mm	ØD mm	E mm	F mm	Ød mm	n holes
RF/2-125	245	300	355	15	191	10	4
RF/4-125	245	300	355	15	191	10	4
RF/2-160	245	300	355	15	191	10	4
RF/2-160/H	245	300	355	15	191	10	4
RF/4-160	245	300	355	15	191	10	4
RF/2-200	330	435	457	15	246	12	4
RF/4-200	330	435	457	15	259	12	4
RF/4-250	330	435	552	15	327	12	4
RF/4-250T	330	435	552	15	327	12	4
RF/6-250	330	435	552	15	327	12	4
RF/4-315	330	435	552	15	327	12	4
RF/4-315T	330	435	552	15	327	12	4
RF/6-315	330	435	552	15	327	12	4

type	A mm	B mm	ØD mm	H mm	Ød mm	n holes
RF/x-355x	450	560	765	416	12	4
RF/x-400x	450	560	765	416	12	4
RF/4-450T/H	535	630	765	421	12	4
RF/x-450x	535	630	765	458	12	4
RF/x-500x	590	710	1000	535	12	4
RF/x-560x	750	900	1000	632	14	4
RF/x-630x	750	900	1000	623	14	4

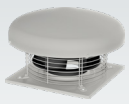

MOUNTING ACCESSORIES - Mounting type A

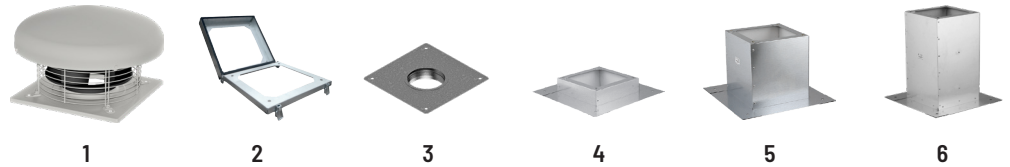
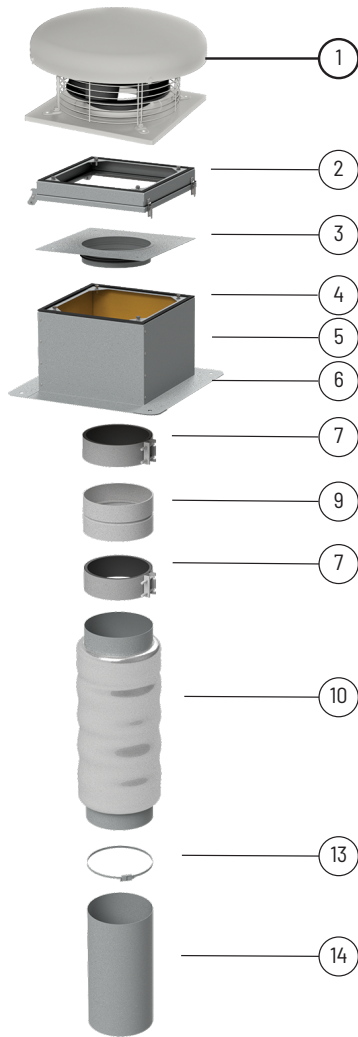

type	swing module U	plate with stub PZK	flat roof up RSS	flat roof up RS	flat roof up RSA
RF/X-125	U 300	PZK-125	RSS 300	RS 300	RSA 300
RF/X-160	U 300	PZK-160	RSS 300	RS 300	RSA 300
RF/X-200	U 435	PZK-200	RSS 435	RS 435	RSA 435
RF/X-250	U 435	PZK-250	RSS 435	RS 435	RSA 435
RF/X-315	U 435	PZK-315	RSS 435	RS 435	RSA 435
RF/X-355	U 560	-	RSS 560	RS 560	RSA 560
RF/X-400	U 560	-	RSS 560	RS 560	RSA 560
RF/X-450	U 630	-	RSS 630	RS 630	RSA 630
RF/X-500	U 710	-	RSS 710	RS 710	RSA 710
RF/X-560	U 905	-	RSS 905	RS 905	RSA 905
RF/X-630	U 905	-	RSS 905	RS 905	RSA 905

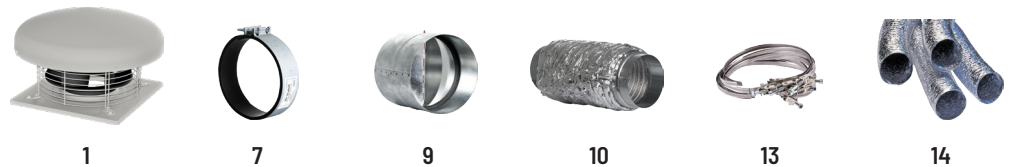

type	anti-vibration bandage ACOP PL	backflow preventer CAR-PL	duct silencer AKU-COMP	duct clips SBF	ventilation duct VENTAL
RF/X-125	ACOP PL 125	CAR-PL 125	AKU-COMP 125	SBF 60-135	VENTAL 127
RF/X-160	ACOP PL 160	CAR-PL 160	AKU-COMP 160	SBF 60-165	VENTAL 165
RF/X-200	ACOP PL 200	CAR-PL 200	AKU-COMP 200	SBF 60-215	VENTAL 203
RF/X-250	ACOP PL 250	CAR-PL 250	AKU-COMP 250	SBF 60-325	VENTAL 254
RF/X-315	ACOP PL 315	CAR-PL 315	AKU-COMP 315	SBF 60-325	VENTAL 315
RF/X-355	-	-	-	-	-
RF/X-400	-	-	-	-	-
RF/X-450	-	-	-	-	-
RF/X-500	-	-	-	-	-
RF/X-560	-	-	-	-	-
RF/X-630	-	-	-	-	-

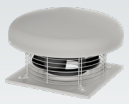

MOUNTING ACCESSORIES - Mounting type B

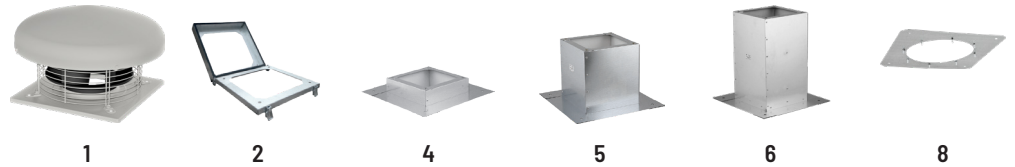
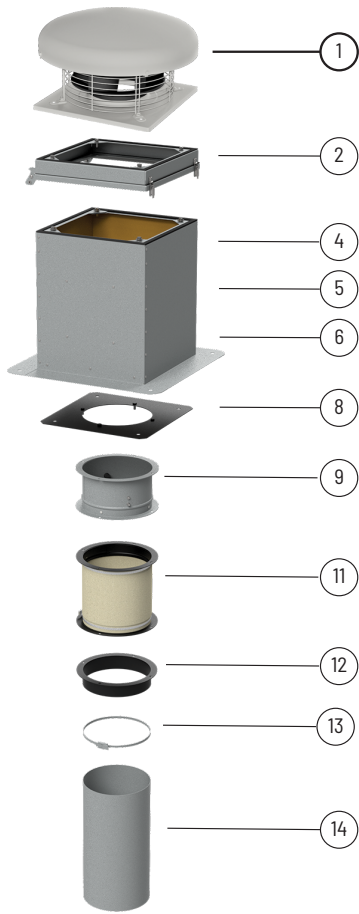

type	swing module U	flat roof up RSS	flat roof up RS	flat roof up RSA	mounting plate P
RF/X-125	U 300	RSS 300	RS 300	RSA 300	P 300
RF/X-160	U 300	RSS 300	RS 300	RSA 300	P 300
RF/X-200	U 435	RSS 435	RS 435	RSA 435	P 435
RF/X-250	U 435	RSS 435	RS 435	RSA 435	P 435
RF/X-315	U 435	RSS 435	RS 435	RSA 435	P 435
RF/X-355	U 560	RSS 560	RS 560	RSA 560	P 560
RF/X-400	U 560	RSS 560	RS 560	RSA 560	P 560
RF/X-450	U 630	RSS 630	RS 630	RSA 630	P 630
RF/X-500	U 710	RSS 710	RS 710	RSA 710	P 710
RF/X-560	U 905	RSS 905	RS 905	RSA 905	P 905
RF/X-630	U 905	RSS 905	RS 905	RSA 905	P 905



type	backdraught dumper KZD	flexible connector ZDPO	stub pipe K	duct clips SBF	ventilation duct VENTAL
RF/X-125	KZD 300	ZDPO 300	K 300	SBF 60-135	VENTAL 165
RF/X-160	KZD 300	ZDPO 300	K 300	SBF 60-165	VENTAL 165
RF/X-200	KZD 435	ZDPO 435	K 435	SBF 60-215	VENTAL 254
RF/X-250	KZD 435	ZDPO 435	K 435	SBF 60-325	VENTAL 254
RF/X-315	KZD 435	ZDPO 435	K 435	SBF 60-325	VENTAL 254
RF/X-355	KZD 560-N	ZDPO 560	K 560	-	-
RF/X-400	KZD 560-N	ZDPO 560	K 560	-	-
RF/X-450	KZD 630-N	ZDPO 630	K 630	-	-
RF/X-500	KZD 710-N	ZDPO 710	K 710	-	-
RF/X-560	KZD 905-N	ZDPO 905	K 905	-	-
RF/X-630	KZD 905-N	ZDPO 905	K 905	-	-

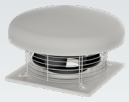

MOUNTING ACCESSORIES - Mounting type C

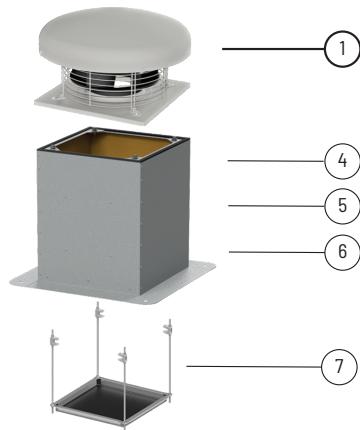

	1	4	5	6	7
type	flat roof up RSS	flat roof up RS	flat roof up RSA	flat roof up RSA	drip tray T
RF/X-125	RSS 300	RS 300	RSA 300	RSA 300	T 300
RF/X-160	RSS 300	RS 300	RSA 300	RSA 300	T 300
RF/X-200	RSS 435	RS 435	RSA 435	RSA 435	T 435
RF/X-250	RSS 435	RS 435	RSA 435	RSA 435	T 435
RF/X-315	RSS 435	RS 435	RSA 435	RSA 435	T 435
RF/X-355	RSS 560	RS 560	RSA 560	RSA 560	T 560
RF/X-400	RSS 560	RS 560	RSA 560	RSA 560	T 560
RF/X-450	RSS 630	RS 630	RSA 630	RSA 630	T 630
RF/X-500	RSS 710	RS 710	RSA 710	RSA 710	T 710
RF/X-560	RSS 905	RS 905	RSA 905	RSA 905	T 905
RF/X-630	RSS 905	RS 905	RSA 905	RSA 905	T 905

Article numbers

43527200 U 300	43526510 RSS 300	40521815 ACOP PL 125	40521020-01 CAR-PL 125	40521520 AKU-COMP 125	18520165-01 SBF 60-165
43527210 U 435	43526520 RSS 435	40521820 ACOP PL 160	40521030-01 CAR-PL 160	40521530 AKU-COMP 160	18520215-01 SBF 60-215
43527220 U 560	43526530 RSS 560	40521825 ACOP PL 200	40521040-01 CAR-PL 200	40521540 AKU-COMP 200	18520325-01 SBF 60-325
43527230 U 630	43526540 RSS 630	40521830 ACOP PL 250	40521050-01 CAR-PL 250	40521550 AKU-COMP 250	11027127 VENTAL 127
43527240 U 710	43526550 RSS 710	40521835 ACOP PL 315	40521060-01 CAR-PL 315	40521560 AKU-COMP 315	11027165 VENTAL 165
43527250 U 905	43526711 RS 300	43526300 P 300	43527300 KZD 300	43527400 ZDPO 300	11027203 VENTAL 203
43528610 PZK-125	43526020 RS 435	43526310 P 435	43527310 KZD 435	43527410 ZDPO 435	11027254 VENTAL 254
43528620 PZK-160	43526030 RS 560	43526320 P 560	43527320 KZD 560	43527420 ZDPO 560	11027315 VENTAL 315
43528630 PZK-200	43526040 RS 630	43526330 P 630	43527330 KZD 630	43527430 ZDPO 630	43527500 T 300
43528640 PZK-250	43526050 RS 710	43526340 P 710	43527340 KZD 710	43527440 ZDPO 710	43527510 T 435
43528650 PZK-315	43526110 RSA 300			43526400 K 300	43527520 T 560
	43526120 RSA 435			43526410 K 435	43527530 T 630
	43526130 RSA 560			43526420 K 560	43527540 T 710
	43526140 RSA 630			43526430 K 630	43527550 T 905
	43526150 RSA 710			43526440 K 710	

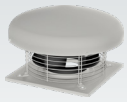

ELECTRICAL ACCESSORIES



type	wall thermostat	duct thermostat	air quality sensor	humidistat	thyristor regulator	rthyristor regulator	thyristor regulator	2-pos 6-speed thyristor regulator
	TS	TK-21	SQA	HIG-2	REB N	REB NE	VREB	RND-1
RF/2-125S	TS	TK-1	SQA	HIG-2	REB-1N	REB-1NE	VREB 1.5H	RND-1
RF/4-125S	TS	TK-1	SQA	HIG-2	REB-1N	REB-1NE	VREB 1.5H	RND-1
RF/2-160S	TS	TK-1	SQA	HIG-2	REB-1N	REB-1NE	VREB 1.5H	RND-1
RF/2-160S/H	TS	TK-1	SQA	HIG-2	REB-1N	REB-1NE	VREB 1.5H	RND-1
RF/4-160S	TS	TK-1	SQA	HIG-2	REB-1N	REB-1NE	VREB 1.5H	RND-1
RF/4-160S/L	TS	TK-1	SQA	HIG-2	REB-1N	REB-1NE	VREB 1.5H	RND-1
RF/2-200S	TS	TK-1	SQA	HIG-2	REB-2,5N	REB-2,5NE	VREB 2.5H	RND-1
RF/4-200S	TS	TK-1	SQA	HIG-2	REB-1N	REB-1NE	VREB 1.5H	RND-1
RF/4-250S	TS	TK-1	SQA	HIG-2	REB-2,5N	REB-2,5NE	VREB 2.5H	RND-1
RF/4-250T	TS + DILM7-10	TK-1 + DILM7-10	SQA + DILM7-10	HIG-2 + DILM7-10	-	-	-	-
RF/6-250S	TS	TK-1	SQA	HIG-2	REB-1N	REB-1NE	VREB 1.5H	RND-1
RF/4-315S	TS	TK-1	SQA	HIG-2	REB-2,5N	REB-2,5NE	VREB 2.5H	RND-1
RF/4-315T	TS + DILM7-10	TK-1 + DILM7-10	SQA + DILM7-10	HIG-2 + DILM7-10	-	-	-	-
RF/6-315S	TS	TK-1	SQA	HIG-2	REB-1N	REB-1NE	VREB 1.5H	RND-1
RF/4-355S	TS	TK-21	SQA	HIG-2	REB-5	-	-	-
RF/4-355T	TS + DILM7-10	TK-21 + DILM7-10	SQA + DILM7-10	HIG-2 + DILM7-10	-	-	-	-
RF/6-355T	TS + DILM7-10	TK-21 + DILM7-10	SQA + DILM7-10	HIG-2 + DILM7-10	-	-	-	-
RF/4-400S	TS	TK-21	SQA	HIG-2	REB-5	-	-	-
RF/4-400T	TS + DILM7-10	TK-21 + DILM7-10	SQA + DILM7-10	HIG-2 + DILM7-10	-	-	-	-
RF/6-400S	TS	TK-21	SQA	HIG-2	REB-2,5 N	REB-2,5 NE	VREB 2.5H	RND-1
RF/6-400T	TS + DILM7-10	TK-21 + DILM7-10	SQA + DILM7-10	HIG-2 + DILM7-10	-	-	-	-
RF/4-450S	TS	TK-21	SQA	HIG-2	REB-10	-	-	-
RF/4-450T/L	TS + DILM7-10	TK-21 + DILM7-10	SQA + DILM7-10	HIG-2 + DILM7-10	-	-	-	-
RF/4-450T/H	TS + DILM7-10	TK-21 + DILM7-10	SQA + DILM7-10	HIG-2 + DILM7-10	-	-	-	-
RF/6-450T	TS + DILM7-10	TK-21 + DILM7-10	SQA + DILM7-10	HIG-2 + DILM7-10	-	-	-	-
RF/4-500T/L	TS + DILM7-10	TK-21 + DILM7-10	SQA + DILM7-10	HIG-2 + DILM7-10	-	-	-	-
RF/6-500S/L	TS	TK-21	SQA	HIG-2	REB-5	-	-	-
RF/6-500S/H	TS	TK-21	SQA	HIG-2	REB-5	-	-	-
RF/6-500T	TS + DILM7-10	TK-21 + DILM7-10	SQA + DILM7-10	HIG-2 + DILM7-10	-	-	-	-
RF/4-560T/L	TS + DILM7-10	TK-21 + DILM7-10	SQA + DILM7-10	HIG-2 + DILM7-10	-	-	-	-
RF/4-560T/H	TS + DILM7-10	TK-21 + DILM7-10	SQA + DILM7-10	HIG-2 + DILM7-10	-	-	-	-
RF/6-560S	TS	TK-21	SQA	HIG-2	REB-5	-	-	-
RF/6-560T	TS + DILM7-10	TK-21 + DILM7-10	SQA + DILM7-10	HIG-2 + DILM7-10	-	-	-	-
RF/4-630T	TS + DILM7-10	TK-21 + DILM7-10	SQA + DILM7-10	HIG-2 + DILM7-10	-	-	-	-

Article numbers

91040997 DILM7-10	40025345 TS 40025320 TK-21 40025140 SQA 40025150 HIG-2	40025010 REB-1N 40025030 REB-2,5N 40025051 REB-5 40025055 REB-10 40025020 REB-1NE 40025040 REB-2,5NE	40025830 VREB 1.5H 40025840 VREB 2.5H	40025630 RND-1
-------------------	---	---	--	----------------

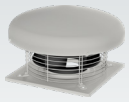

ELECTRICAL ACCESSORIES



type	regulator	transformer regulator	transformer regulator	transformer regulator	2-adjustable transformer regulator	2-adjustable transformer regulator	inverter	service switch
	ERV	RMB	RVS	RMT	SC2	SC2A	L	R-S
RF/2-125S	ERV-3	RMB-1.5	RVS-1.5	-	SC2-1-15L25	SC2A1-15L25	-	R-S 1F-2B SP 16A
RF/4-125S	ERV-3	RMB-1.5	RVS-1.5	-	SC2-1-15L25	SC2A1-15L25	-	R-S 1F-2B SP 16A
RF/2-160S	ERV-3	RMB-1.5	RVS-1.5	-	SC2-1-15L25	SC2A1-15L25	-	R-S 1F-2B SP 16A
RF/2-160S/H	ERV-3	RMB-1.5	RVS-1.5	-	SC2-1-15L25	SC2A1-15L25	-	R-S 1F-2B SP 16A
RF/4-160S	ERV-3	RMB-1.5	RVS-1.5	-	SC2-1-15L25	SC2A1-15L25	-	R-S 1F-2B SP 16A
RF/4-160S/L	ERV-3	RMB-1.5	RVS-1.5	-	SC2-1-15L25	SC2A1-15L25	-	R-S 1F-2B SP 16A
RF/2-200S	ERV-3	RMB-1.5	RVS-1.5	-	SC2-1-15L25	SC2A1-15L25	-	R-S 1F-2B SP 16A
RF/4-200S	ERV-3	RMB-1.5	RVS-1.5	-	SC2-1-15L25	SC2A1-15L25	-	R-S 1F-2B SP 16A
RF/4-250S	ERV-3	RMB-1.5	RVS-1.5	-	SC2-1-15L25	SC2A1-15L25	-	R-S 1F-2B SP 16A
RF/4-250T	-	-	-	RMT-1.5	-	SC2A4-15L55	L 0.4kW	R-S 3F-3B SP 10A
RF/6-250S	ERV-3	RMB-1.5	RVS-1.5	-	SC2-1-15L25	SC2A1-15L25	-	R-S 1F-2B SP 16A
RF/4-315S	ERV-3	RMB-1.5	RVS-1.5	-	SC2-1-15L25	SC2A1-15L25	-	R-S 1F-2B SP 16A
RF/4-315T	-	-	-	RMT-1.5	-	SC2A4-15L55	L 0.4kW	R-S 3F-3B SP 10A
RF/6-315S	ERV-3	RMB-1.5	RVS-1.5	-	SC2-1-15L25	SC2A1-15L25	-	R-S 1F-2B SP 16A
RF/4-355S	ERV 3	RMB 3,5	RVS 3	-	-	SC2A1-25L25	-	RS 1F-2B SP 16A
RF/4-355T	-	-	-	RMT 1,5	-	SC2A4-15L55	L 0.4kW	RS 3F-3B SP 10A
RF/6-355T	-	-	-	RMT 1,5	-	SC2A4-15L55	L 0.4kW	RS 3F-3B SP 10A
RF/4-400S	ERV 3	RMB 3,5	RVS 3	-	-	SC2A1-35L25	-	RS 1F-2B SP 16A
RF/4-400T	-	-	-	RMT 1,5	-	SC2A4-15L55	L 0.75kW	RS 3F-3B SP 10A
RF/6-400S	ERV 3	RMB 1,5	RVS 3	-	-	SC2A1-15L25	-	RS 1F-2B SP 16A
RF/6-400T	-	-	-	RMT 1,5	-	SC2A4-15L55	L 0.4kW	RS 3F-3B SP 10A
RF/4-450S	ERV 10	RMB 8	RVS 7	-	-	SC2A1-75L25	-	RS 1F-2B SP 16A
RF/4-450T/L	-	-	-	RMT 2,5	-	SC2A4-25L55	L 0.75kW	RS 3F-3B SP 10A
RF/4-450T/H	-	-	-	RMT 5	-	SC2A4-40L55	L 1.5kW	RS 3F-3B SP 10A
RF/6-450T	-	-	-	RMT 1,5	-	SC2A4-15L55	L 0.4kW	RS 3F-3B SP 10A
RF/4-500T/L	-	-	-	RMT 5	-	SC2A4-40L55	L 1.5kW	RS 3F-3B SP 10A
RF/6-500S/L	ERV 3	RMB 3,5	RVS 3	-	-	SC2A1-35L25	-	RS 1F-2B SP 16A
RF/6-500S/H	ERV 3	RMB 3,5	RVS 3	-	-	SC2A1-35L25	-	RS 1F-2B SP 16A
RF/6-500T	-	-	-	RMT 1,5	-	SC2A4-15L55	L 0.4kW	RS 3F-3B SP 10A
RF/4-560T/L	-	-	-	RMT 8	-	SC2A4-60L55	L 2.2kW	RS 3F-3B SP 10A
RF/4-560T/H	-	-	-	RMT 8	-	SC2A4-60L55	L 2.2kW	RS 3F-3B SP 10A
RF/6-560S	ERV 5	RMB 8	RVS 7	-	-	SC2A1-50L25	-	RS 1F-2B SP 16A
RF/6-560T	-	-	-	RMT 2,5	-	SC2A4-25L55	L 0.75kW	RS 3F-3B SP 10A
RF/4-630T	-	-	-	RMT 8	-	SC2A4-110L55	L 4,0kW	RS 3F-3B SP 10A

Article numbers

40025046 ERV 3	40025060 RMB 1,5	40025251 SC2A1-15L25	40016302 L 0,4kW	91040907-01 R-S 1-F + SP, 10A	91040907-02 RS 1F-2B SP 16A
40025053 ERV 5	40025070 RMB 3,5	40025253 SC2A1-25L25	40016312 L 0,75kW		91040908-01 RS 3F-3B SP 10A
40025054 ERV 10	40025080 RMB 8	40025255 SC2A1-35L25	40016322 L 1,5kW		
	40025232 RVS 1,5	40025257 SC2A1-50L25	40016332 L 2,2kW		
	40025234 RVS 3	40025259 SC2A1-75L25	40016454 L 4,0kW		
	40025236 RVS 7	40025270 SC2A4-15L55			
	40025100 RMT 1,5	40025272 SC2A4-25L55			
	40025105 RMT 2,5	40025274 SC2A4-40L55			
	40025115 RMT 5	40025276 SC2A4-60L55			
	40025120 RMT 8				